

REFLEXX
Owner's Manual

BAYLINER®

Putting Quality First

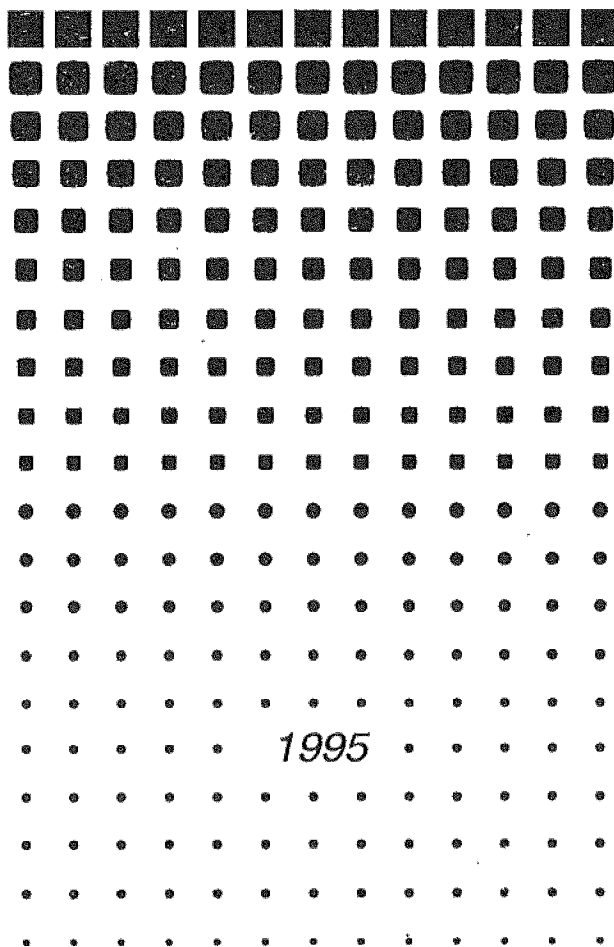

Welcome Aboard

This manual has been prepared to assist you in the operation and care of your Bayliner boat. Please read through it completely, as familiarization with its contents can contribute to the more effective operation of your boat.

Your Bayliner boat is part of a carefully engineered, power-matched package which includes a jet unit and trailer designed to provide optimum performance and utility. Installing a different engine or adding accessories that will affect the boat's running trim may void your warranty.

Your boat's mechanical and electrical systems were designed to meet safety standards in effect at the time the boat was built. Some of these standards were mandated by Federal law, others are considered industry norms. All of them were designed to insure your safety, and the safety of other people, vessels and property around you. **To maintain the integrity and safety of your boat, only qualified people should perform maintenance on the steering, propulsion, engine control, fuel, environmental control, or electrical systems. Modifications may only be made with the expressed written approval of Bayliner Marine Corporation.** Failure to maintain these systems as designed could violate Federal law, and could expose you and other people to the danger of bodily injury or accidental death. We recommend that you follow the instructions provided in this handbook, in the engine owner's manual, and in the accessory instruction sheets included with your boat, motor and trailer package. We also recommend that you perform the following steps:

1. Make certain that you receive a full explanation of all systems from the dealer before taking delivery of your boat. Your selling dealer is your key to service. If you experience any problems with your new Bayliner, immediately contact the dealership. If for any reason your selling dealer is unable to help, call us direct on our customer service hotline for assistance. The number is (206) 435-8957.
2. Read this manual thoroughly, paying particular attention to the subjects of **fueling, checking for fumes, starting, carbon monoxide, loading limits, recommendations for safety, and warranty.**
3. Practice—all members of the family should be familiar with the operation and systems of your boat.

- Participate in a safe boating course. Call the local office of the United States Power Squadrons, the United States Coast Guard Auxiliary, The Red Cross, or your state boating law enforcement agency for the date and location of their next class. Inquires can be made to the Boating Safety Hotline, 1-800-368-5647 or to the Boat U.S. Foundation information number 1-800-336-BOAT.

The hazard warning symbols shown below are used throughout this manual to call attention to potentially dangerous situations which could lead to either personal injury or product damage. We urge you to read these warnings carefully and follow all safety recommendations.

DANGER

The symbol shown above alerts you to immediate hazards which **WILL** cause *severe personal injury or death* if the warning is ignored.

WARNING

The symbol shown above alerts you to hazards or unsafe practices which **COULD** result in *severe personal injury or death* if the warning is ignored.

CAUTION

The symbol shown above alerts you to hazards or unsafe practices which **COULD** result in *minor personal injury, or cause product or property damage* if the warning is ignored.

NOTICE

The symbol shown above calls attention to installation, operation, or maintenance information which is important to proper operation, but is not hazard-related.

There is information in this manual related to the following Bayliner boat:

1401 Reflexx

Due to our commitment to product improvement, we reserve the right to change, without notice or other obligation, the specifications or other information contained in this publication.

▲ WARNING

A qualified operator must be in control of the boat at all times. Do not operate the boat while under the influence of alcohol or drugs. Never operate your boat at speeds which exceed the operator's ability to react if an emergency develops. At night, turn on the appropriate navigation lights and cruise at a reduced speed that will allow you plenty of time to avoid dangerous situations.

▲ WARNING

The Reflexx is classified as a Class "A" motorboat. It is not a toy. Operators should be at least sixteen years old or under the direction of a responsible adult. Be aware that there may be local and/or state laws covering the legal requirements for boat operation.

▲ WARNING

Manufactured with 1,1,1-Trichloroethane, a substance which harms public health and environment by destroying ozone in the upper atmosphere.

CONTENTS

PREPARATION	5
Recommendations for Safety	5
Safety Equipment	9
Tool Chest	10
Miscellaneous Items	10
Static Float Attitude	10
Other Tips	10
TRAILERING	11
Launching	13
Reloading	14
OPERATING	15
Fueling Procedures	15
Fuel Capacity	15
“Built-In” Fuel Tank	16
Starting	17
Carbon Monoxide	19
Before You Leave	20
Maneuvering	21
Basic Maneuvering	21
Docking	25
Clearing a Clogged Jetdrive	26
Boat Performance	28
Boat Running Attitude	28
Instruments	28
COMPONENTS/SYSTEMS	29
Electrical System	29
Starter Motor	30
Bilge Blower	30
Bilge Pump	31
Navigation Lights	32
Fuel System	32
GENERAL MAINTENANCE AND REPAIRS	33
Bilges/Engine Compartment	34
Topside Areas	34
Hull	35
STORAGE	37
NAUTICAL TERMS	39
WARNING LABELS	40
WIRING DIAGRAM	43
LIMITED WARRANTY	44

PREPARATION

Prior to leaving on your first outing (or, for that matter, any outing) there are certain items to check and activities to perform. Familiarize yourself with your boat before launching, and consider the following suggestions:

Recommendations for Safety

1. **Personal Flotation Devices:**

One Coast Guard approved personal flotation device (PFD) of suitable size is required for each person aboard a recreational boat. New PFDs bearing Coast Guard approval are now identified as Types I, II, III, or IV.

Requirements for boats less than sixteen feet (16') in length: One (1) Type I, II, III, or IV PFD for each person on board.

2. Bayliner strongly recommends that everyone aboard wear a PFD at all times. Always have children wear PFDs. Always keep PFD's readily accessible and check those devices intended for young children for fit and performance in the water. Never hesitate to have "all hands" wear lifesaving devices whenever circumstances cause the slightest doubt about safety.
3. Bayliner recommends that the operators of the Reflexx be at least 16 years of age or under the direction of a responsible adult . Be aware that there may be local and/or state laws covering the legal age requirements for boat operation.
4. Do not exceed the load (in pounds) or people capacity found on the U.S. Coast Guard placard attached to your boat and take care to properly load your boat. Maintain adequate freeboard at all times. Consider the sea conditions, the duration of the trip, the weather and the experience of the personnel on board.
5. The operator of the boat is responsible for the safety of his passengers as well as his own. You should insure that everyone aboard is properly and securely seated in appropriate seating locations before starting. You should not allow sitting on seatbacks, gunnels, bows, transoms, or sun lounges while underway. In many states it is illegal.

⚠ DANGER

Do not allow anyone to ride on parts of the boat that were not designed for such use. Sitting up on seat backs, bow riding, gunwale riding or transom riding while underway is especially hazardous and will cause personal injury or death.

6. Falls overboard are the greatest cause of injury or death while afloat. Eliminate tripping hazards where possible, make conspicuous those that must remain, and require that everybody on board wear proper footwear.
7. Boat operators are required by law to file a Boating Accident Report with their state boating law enforcement agency when their boat is involved in certain boating accidents. A boating accident must be reported if (1) there is loss of life or probable loss of life, or (2) there is personal injury requiring medical treatment beyond first aid, or (3) there is property damage to boats or other property where the damage value exceeds \$200.00, or (4) there is complete loss of the boat. For further information and assistance contact the local law enforcement authorities. Copies of the U.S. Coast Guard Boating Accident Report are available by calling the U.S. Coast Guard Safety Hotline at (800)368-5647.
8. Never drive the boat directly behind a water skier. At 25 m.p.h. the boat will overtake a fallen skier who was 200 feet in front in 5 seconds.

⚠ WARNING



To maintain steerage you must maintain thrust. You will not be able to steer after shutting down the throttle or shutting off the engine. Keep the throttle on if you need to maneuver. Do not travel at high speed directly towards any object closer than 200'.

9. Understand the meanings of navigation buoys, and never moor to one. (It is a Federal offense.)
10. Know the various distress signals. A recognized distress signal used on small boats is to slowly and repeatedly raise and lower the arms outstretched to each side.
11. Storm signals are for your information and safety. Learn them and be guided accordingly.
12. A special flag (red flag with a white diagonal stripe or white and blue international "Alpha") flown from a boat or buoy means diving operations are underway nearby. Approach with caution and stay clear by at least 25 yards.
13. Make sure your boat's motor is turned off before allowing people to swim anywhere near your boat. Shut the motor OFF and remove the key from the ignition switch so that nobody will accidentally start the motor while swimmers are nearby. Also, slow down and exercise extreme caution any time you are cruising in an area where there might be swimmers or water skiers in the water. Always keep a down skier in sight and on the operator's side of the boat when approaching the skier. Never back up to anyone in the water.
14. Watch your wake. It might capsize a small craft. You are responsible for damage caused by your wake. Pass through anchorages at a minimum speed.
15. Learn and abide by common boating "rules of the road".
16. Always have up-to-date charts of your cruising area on board.
17. Keep an alert lookout. The operator is required by law to "maintain a proper lookout" by sight (and hearing). He must insist that he has an unobstructed view particularly to the front. No passengers, or load should block his view when operating the boat above idle speed. Be sure that other boats or objects are not in your path before making quick turns. The Reflexx is highly maneuverable, other boaters may not expect you to turn as quickly as is possible and because of its small size, the Reflexx may not be seen by other boaters.
18. Always instruct at least one person on board in the basics of boat handling in case you are disabled or fall overboard.

19. Consider what action you would take under various emergency conditions such as a person overboard, fog, fire, a damaged hull or other bad leaks, motor breakdown, severe storm or collision.
20. If your boat ever capsizes, remember that it will continue to float (if not overloaded, powerboats less than 20' in length will float when swamped). It is usually best to remain with it. You are more easily located by a search plane or boat.
21. Do not drive over ski jumps. You may injure yourself and others or damage the boat.
22. Do not attempt to run the boat in the ocean surf. It is illegal in some areas and can cause serious injuries or damage to the boat.
23. Keep fire fighting and lifesaving equipment in good condition and readily available at all times.
24. Do not test fire extinguishers by squirting small amounts of the agent. The extinguisher might not work when needed. Always follow approved instructions when checking fire extinguishers.
25. Have an adequate anchor and sufficient line (at least six times the depth of the water) to assure a secure hold in all types of weather and sea conditions.
26. Keep electrical equipment and wiring in good condition. Knife switches or other arcing devices should **never** be installed in fuel compartments. Allow ample ventilation around batteries.
27. Good housekeeping in your boat is important. Cleanliness diminishes the probability of fire.
28. Know your fuel tank capacity and cruising range. If it is necessary to carry additional fuel, do so only in proper containers. Take special precautions to prevent the accumulation of fuel vapors in confined spaces. **Do not store fuel on the forward deck.**
29. Before departing on a boat trip, advise a responsible friend or relative about where you intend to cruise. Be sure to give that person a good description of your boat. Keep them advised of any changes in your cruise plans. These precautions will enable your friend or relative to tell the Coast Guard where to search for you and what type of boat to look for if you fail to return. Be sure to advise the same person when you complete your trip to prevent any false alarms about your safety.

30. Your local United States Coast Guard Auxiliary, the United States Power Squadrons, The Red Cross, and your state boating law enforcement agency offer safe boating classes several times a year. These are comprehensive courses, and are generally of minimal cost to you. Call your local U.S. Coast Guard Auxiliary, Power Squadron Flotilla , or your state agency for the time and place of their next class. Inquires can be made to the Boating Safety Hotline, 1-800-368-5647 or to the Boat U.S. Foundation information number 1-800-336-BOAT.

Safety Equipment

The following safety equipment is required by the U.S. Coast Guard:

1. Personal flotation devices: One (1) Type I, II, III, or IV PFD for each person on board.
2. Fire extinguishers: At least one (1) type B-I (located for easy access)
3. Whistle: Any device capable of making an "efficient sound signal" audible for at least ½ mile.
4. Bell: Any device capable of making an "efficient sound signal" .
5. Visual distress signals (flares): Required only when operating at night (must have unexpired dates).

The following safety-related items should be considered as part of your standard equipment:

6. Visual distress signals: Day type (must have unexpired dates)
7. Fenders, lines
8. Flashlight(s) with extra batteries
9. Charts of your intended cruising area
10. First aid kit
11. Anchor and adequate line
12. Oar or paddle

Tool Chest

1. Assorted screwdrivers (Phillips and flat blade)
2. Pliers (regular, vise-grip, and water pump)
3. Wrenches (box, open-end, allen, adjustable)
4. Socket set (metric or U.S. standard as appropriate)
5. Electrical tape

Miscellaneous Items

1. Engine and accessories manuals
2. Spare set of spark plugs and other ignition parts
3. An assortment of spare fuses

Static Float Attitude

The static floating attitude of your boat can be affected by many variables. Optional equipment and loading of gear are the biggest contributors to a boat's list (a continuous lean to one side). After launching, the floating attitude of any new boat can be adjusted. If your boat lists to one side, load heavy items on the opposite side until the boat floats more level. Load the remainder of your gear evenly after that.

Other Tips

1. When commissioning a new boat, do not plan an extensive trip or party until you have had a shakedown cruise to make sure all equipment on your boat is functioning properly and you are familiar with its operation.
2. Use fenders to protect your boat's hull whenever mooring next to floats, piers, or other boats.
3. Carry plenty of line that is properly sized to your boat. We suggest at least two 15' lengths of 3/8" nylon line.

TRAILERING

An important part of your recreational boat package is your trailer, which was specifically designed for your boat. We recommend that you read your Trailer Owner's Manual thoroughly and become familiar with your trailer's features before towing or launching your boat. The following information highlights several things you will want to consider when trailering your boat.

1. Check the wheel bearings for smooth operation and proper amount of grease before and after the first several times you tow your trailer. Make it a habit to check the bearings at least every 90 days after that. Also, you'll want to clean, inspect and repack the bearings with grease before storing your trailer over the winter, or any other time you plan to store the trailer for an extended period of time. Make it a habit to feel the wheel hubs each time you stop for gas or refreshments. If the hub feels abnormally hot, it may indicate bearing trouble. Allow the hub to cool and inspect the bearings to determine the problem. It is wise to have a spare set of wheel bearings, races, seals and cotter keys in case you need to replace them on the road.
2. Check that the tires are properly inflated for the load the trailer will be carrying prior to each trip. Underinflated tires will heat up rapidly and tire damage is likely to occur. You should carry a spare wheel and tire, which also should be checked for proper inflation before each trip. Don't forget to bring along a jack and any tools necessary for changing the tire.
3. Check the wheel lug nuts for security before each trip.
4. Consult your state laws for trailer brake requirements and make sure your trailer is properly equipped (laws vary from state to state).
5. Check the trailer's undercarriage for loose parts. Also check the springs for proper operation or possible damage.
6. Examine the wire harness connector plug for corrosion or broken prongs. Once you have hooked the trailer to your tow vehicle, perform a functional test of the lights to verify that they work properly. Note that some autos will require heavy-duty flasher units to make turn signals operate properly. You may wish to consult your auto dealer's service department for their recommendations.

7. Prepare your boat for trailering by making sure the engine compartment cover is securely latched down and the rest of your equipment is distributed evenly and stowed securely (you are legally responsible for anything that blows out of the boat). The load should be balanced, as too much or too little weight on the trailer's tongue will cause difficult steering and tow vehicle sway. A rough rule of thumb is that 5% to 10% of the boat and trailer weight should rest on the tongue. Do not load your boat so that the gross weight rating of your trailer is exceeded.
8. Check the condition of towing safety chains, transom tie-down straps and winch cables. Replace any that appear worn or unsafe. Your boat should be fastened to the trailer by a line or cable from the winch to the boat's bow eye **and** a safety chain from the winch stand or trailer tongue to the boat's bow eye. The transom straps should be fastened from the left and right trailer frame members to the boat's transom-mounted trailering eyes. Check that the straps are snugged down securely. Note that the transom tie-down straps and winch cables are designed for *normal* towing conditions on paved roads and fairly smooth secondary roads (at slow speeds only). They **should not** be relied upon for *any* lifting application. Also, we recommend the use of additional straps or rope tie-downs for securing your boat to the trailer, especially for longer trips or whenever you expect to encounter rough roads. If in doubt, use extra straps.

⚠ WARNING

Failure to use safety chains between the trailer and the towing vehicle and adequate tie-down straps to hold the boat to the trailer can cause serious accidents. Not using these safety devices can allow the boat and or trailer to come loose while being towed.

Once all your safety checks have been completed, you will be ready to head for the water. However, we highly recommend that you tow your boat to a nearby empty parking lot first and practice maneuvering your trailer until you feel comfortable with it. It helps to have someone to direct you any time you are backing the trailer. If your tow vehicle is not already so equipped, consider installing a right side mirror for improved rearward visibility.

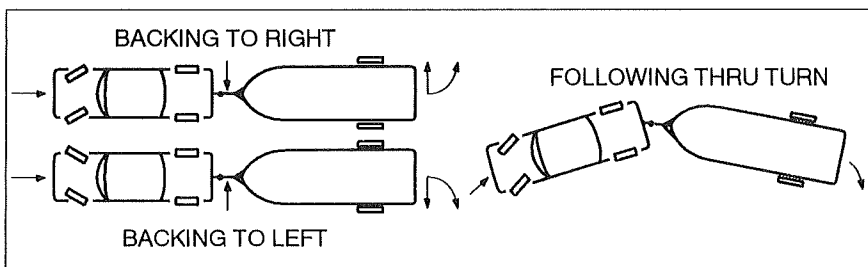

Your tow vehicle will take longer to accelerate and will require more distance to slow down when trailering a boat. Don't tailgate the vehicle ahead of you, as you'll risk "jackknifing" if you should have to stop in an emergency. Open up your following distance from the normal two second interval to at least three or four seconds between your vehicle and the one ahead. Allow even more space in rainy or icy conditions, or at night. Remember to swing wide as you turn to avoid cutting the corner; avoid making any sharp turns.

Launching

When you arrive at the launching ramp and are ready to float your boat off the trailer, make these basic checks to be certain that the launching is a safe operation.

1. Disconnect the trailer's wire harness connector plug from the tow vehicle. This will greatly reduce the chance of blowing out your trailer lights when they become submerged.
2. Feel the trailer's wheel hubs to check for hot bearings. Submerging hot hubs in cold water causes water to be drawn into the bearing caps, so it is best to allow the hubs to cool before proceeding with the launching.
3. Install the hull drain plug at the bottom of the transom. Make sure you tighten it securely.

CAUTION

Failure to install the drain plug securely will result in the boat filling with water when it is launched.

4. Remove and stow the transom trailering straps. Remove the safety chain from the bow eye. In order to maintain control of the boat as it is launched, secure a mooring line of adequate length to the boat's bow cleat and have someone, wearing their life jacket, hold the other end of the line as you back the trailer into the water.
5. Carefully back the trailer down the ramp until the boat floats free. The idea is to back the trailer far enough into the water to float the

boat, but not so far that you submerge the back end of the tow vehicle. If you are launching the boat yourself, remember to set the tow vehicle's emergency brake, place the transmission in PARK (for manual transmissions, shift to FIRST gear and shut the engine OFF), and block both front tires before leaving the vehicle.

6. Loosen the winch and release the winch cable from the bow eye. Tie your boat to the dock with the line from the bow cleat. Immediately board the boat and inspect the engine compartment, storage locker and bilge areas for any sign of leakage. If you find that the boat is taking on water, immediately guide the boat back to the trailer and remove it from the water (see reloading instructions that follow). Pull away from the ramp so others might use it and locate the problem before relaunching the boat. If you cannot find the cause of the leakage, contact your dealer for further assistance.
7. Once your boat is launched, secured to the dock and inspected, carefully pull your trailer clear of the water and park your tow vehicle in an appropriate designated area. Then proceed with starting the boat's motor as instructed in the engine owner's manual.

Reloading

1. To reload your boat onto the trailer, back the trailer into the water until about two-thirds of the bunk assembly is submerged. Don't forget to set the tow vehicle's emergency brake, place the transmission in PARK (for manual transmissions, shift to FIRST gear and shut the engine OFF), and block both front tires before leaving the vehicle. Passengers should disembark prior to retrieval of the boat.
2. An experienced operator should carefully motor the boat onto the partially submerged trailer at idle speed. Exercise extreme caution when approaching the trailer. **DO NOT** power the boat all the way up onto the trailer bunks, as this can cause damage to the boat, motor or trailer. As you proceed forward slowly, the trailer bunks will guide your boat onto the trailer far enough to allow someone to hook the winch cable to the boat's bow eye after you have placed the boat's shifter in the NEUTRAL position and shut down the motor. Use the winch to apply enough tension on the cable to hold the boat in place.
3. Make sure nobody is standing between the boat's bow and the winch, then use the winch to pull the boat onto the trailer until its bow rests against the trailer's bow stop roller.

4. Secure the bow safety chain from the winch stand or trailer tongue to the boat's bow eye. After making certain that all bystanders are out of the way, remove the wheel blocks, release the tow vehicle's emergency brake, and tow the boat clear of the launch ramp so others may use it.
5. Keeping in mind the trailering inspection items mentioned previously, prepare your boat and trailer for the road. Don't forget to remove the drain plug and store it in a safe place; this will allow any accumulated water to empty from the boat as you travel home.
6. Refer to your Trailer Owner's Manual for maintenance and storage details, as well as more specific information concerning other aspects of trailering.

OPERATING

Fueling Procedures

⚠ WARNING

Fuel vapors are explosive and can become trapped in the lower portions of a boat where they might be ignited accidentally. While fueling, all hatches must be closed.

⚠ WARNING

Do not use fuels that incorporate any form of alcohol or alcohol derivatives. Alcohol destroys marine fuel system hoses and components, which could lead to hazardous leaks, fire or explosion.

FUEL CAPACITY	
Model	Tank Capacity (Gallons)
1401 Reflexx	18

NOTE: The listed capacity is the dry volume capacity of the tank. Each tank is vented externally to allow air to escape as the tank is filled. A portion of the volume will include air trapped inside the tank; therefore it is not usually possible to fill the boat's fuel tank to its dry volume capacity.

“Built-In” Fuel Tank

1. If you're going to fuel your boat while it's in the water, be sure it's securely moored to the dock.
2. Turn off all electrical equipment including the engine, radio, bilge blower, lights, etc.
3. Extinguish all cigarettes, cigars or other items that may produce a spark or flame.
4. Close all openings including engine compartment.
5. Have all passengers off the boat during the entire fueling procedure.

N O T I C E

Outboard Motor Oil must be mixed with the gasoline or serious damage to the engine will occur. See the Engine Operation Manual for the gasoline/oil mixing ratio and the new engine gasoline/oil *break-in* mixture.

6. Through-deck fittings are provided for fuel tank filling. Open the fill cap and insert the fuel supply nozzle.

⚠ WARNING

Gasoline vapors are extremely flammable and highly explosive under certain conditions. Always stop the engine and DO NOT smoke or allow open flames or sparks in the area while filling fuel tanks.

7. Often you won't be able to fill the fuel tank to 100% of its dry-rated capacity. This is because the amount of fuel the tank will hold depends, in part, on the boat's floating attitude, which in turn affects the position of the fuel tank and its venting system. If fuel flows out the tank vent, discontinue fueling immediately. The tank will be as full as possible under the current conditions. It is advisable not to overfill the tank anyway, as you want to allow for thermal expansion of the fuel, especially on very hot days.
8. If, when filling the tank, you can't put fuel in at a reasonable rate, check the fuel vent line to see that it's not kinked or plugged.
9. When you have finished fueling, close the fill cap and wipe off any fuel spillage.

10. Open the engine compartment and all openings; inspect, both visually and by smell, for fuel fumes or leakage. Any sign of fuel leakage, or any indication of fumes, must be investigated and corrected prior to starting the engine.

Starting

The engine operating and maintenance manual furnished with your motor describes prestart and starting procedures. The following notes are basic reminders, and are not intended to cover every detail of engine starting. We urge you to thoroughly read and understand your sport jet operator's manual.

1. Inspect, both visually and by smell, for fuel and exhaust leaks .
2. Check steering operation by turning the steering wheel full port and starboard while observing the jet nozzle movement. In addition, regularly check to be sure the original SELF-LOCKING nuts are in place on the "steering connector" between the steering cable and the engine. These nuts must never be replaced by common or non-self-locking nuts which can vibrate off. Have your dealer check your steering system thoroughly at least once a year for proper lubrication, any unusual backlash, and any unusual component wear.
3. Make sure the emergency engine shutdown triggering device is in place and the lanyard is attached to the operator. This device turns off the engine ignition whenever the operator is attached to the lanyard and moves far enough away from the operator's position to activate the switch. It is strongly recommended that the operator use this device.

WARNING

A serious accident can occur if the emergency engine shutoff switch lanyard is not fastened to the boat operator. In order for the emergency engine shutdown system to operate correctly, the lanyard must be physically attached to the operator (around the wrist or securely fastened to a stout piece of clothing, such as a belt, etc.).

4. Run the bilge blower for at least four minutes prior to starting the engine. Leave the blower on until the boat is underway and up to cruising speed, then turn it off.

WARNING

Gasoline vapors are highly explosive. To prevent a possible explosion and fire, check the engine and fuel compartments before each engine start for fumes or accumulation of fuel. Always operate the bilge blower for at least four minutes before engine starting, during the starting process and anytime you are operating your boat below cruising speeds.

5. Before starting the motor, ensure your boat is in deep enough water (at least 2').
6. With the throttle lever in NEUTRAL, turn the ignition key clockwise to start the engine, releasing the key when the engine starts.

CAUTION

Starting the Sport Jet 90 out of the water without a flushing kit operating can result in damage to the unit.

CAUTION

DO NOT continuously operate the starter for more than 15 seconds at a time. Allow at least three minutes for cooling between start attempts.

7. Once the motor has been started, allow it to warm-up for several minutes before getting underway.
8. While the boat is still securely moored to the dock, advance the shift control to forward, to reverse, and into neutral to check shifting operation.

CAUTION

Your Sport Jet 90 pump does not have a gearbox. The impeller is always turning, even when the shifter is in neutral.

9. Your sport jet unit is equipped with overheat and low oil level warning systems. The warning horn sounds when the engine temperature is too high or when the oil level in the reservoir is low. If the alarm sounds immediately reduce engine speed to idle and stop the engine. If the problem is low oil, replenish as necessary. If the alarm continues to sound, have the engine checked by your dealer. Running the engine while overheated will cause damage to it.

Carbon Monoxide

⚠ DANGER

Carbon monoxide (CO) is a poisonous gas that is colorless, odorless and about the same weight as air. It will distribute itself throughout spaces of the boat in dangerous concentrations if proper ventilation is not provided. A person breathing these fumes will become seriously ill. Direct and prolonged exposure will cause brain damage or death. Always run the bilge blower whenever the engine is idling.

Because CO diffuses in the air much more rapidly than easily detectable gases you cannot rely on sight or smell to recognize its presence. CO will be produced anytime materials containing carbon are burned. Common sources of CO are internal combustion engines and open flame devices such as cooking ranges, space heaters, and charcoal grills.

The symptoms of CO poisoning include but are not limited to the following:

1. Watering and itchy eyes
2. Flushed appearance
3. Inattentiveness and the inability to think clearly
4. Ringing in the ears
5. Tightness in the chest
6. Headache and/or throbbing temples
7. Drowsiness and fatigue
8. Incoherence
9. Nausea and/or vomiting
10. Dizziness
11. Collapse
12. Convulsions

If someone is suffering from CO poisoning move the person to fresh air, administer oxygen if available, and contact medical help. If the victim is not breathing perform approved CPR procedures until medical help arrives and takes over.

To help prevent exposure to CO check that ventilation systems are operating properly and for any exhaust leaks. Also be aware of your surroundings. Running your engine in a confined space such as a boathouse or next to a seawall can allow dangerous accumulations of CO. Another boat with an engine running moored nearby can also expose you to dangerous amounts of CO.

Before You Leave

If you have not encountered any problems, you are almost ready to go. (If you did encounter problems, do not attempt to operate your boat until they are corrected.) Before you leave, perform the following steps:

1. Check the operation of equipment such as bilge pumps, running lights, etc.
2. Instruct passengers in the use and location of flotation devices and fire extinguishers.
3. Obtain a reliable weather forecast and plan accordingly for everyone's comfort and safety.
4. Notify a responsible friend or relative of your cruise plans. Upon your return or a change in your cruise schedule, notify that person again in order to avoid unnecessary concern.

Maneuvering

When all of your predeparture checks have been completed, you will be ready to leave the dock.

Basic Maneuvering

Your boat features a jet boat planing hull that has several handling characteristics you should be aware of.

Steering the boat at either idling or cruising speeds will generally require minimal effort.

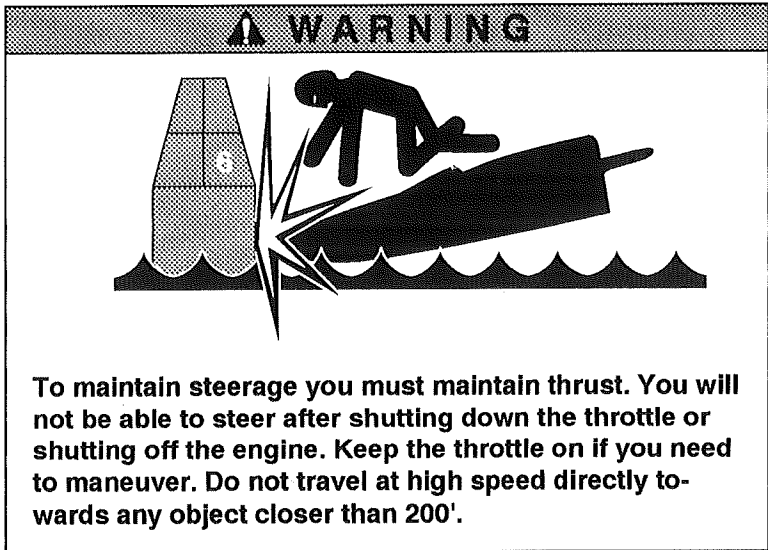

Your boat may wander slightly from port to starboard when operating at idle speed in forward gear. This is a natural characteristic of all jet boat hulls and shouldn't be cause for concern. Simply correct for this wander with small steering adjustments until you get up to cruising speed. Avoid the tendency to over correct for a wandering condition.

Practicing maneuvers at slow speeds will help you to become familiar with all the special handling characteristics associated with your boat.

⚠ WARNING

Always keep hands, feet, hair and clothing away from the jetdrive intake and nozzle. Do not attempt any maintenance or adjustments to the motor or jetdrive unit while the motor is running. Failure to shut off the motor for maintenance or adjustments may cause injury or death.

Remember that all boats steer by the stern (the feeling is much like steering your automobile in reverse). This means that the stern of your boat will swing in the direction opposite to your turn. For example, when you turn the helm wheel to the left, the stern of the boat will swing to the right as the boat goes into a left turn. This is especially important to keep in mind when docking, when operating in close quarters with other boats, or when approaching a swimmer or downed skier in the water.

Always use extreme caution when approaching someone in the water. Approach them at idle speed only, allowing your stern to swing away from them as you get close.

⚠ WARNING

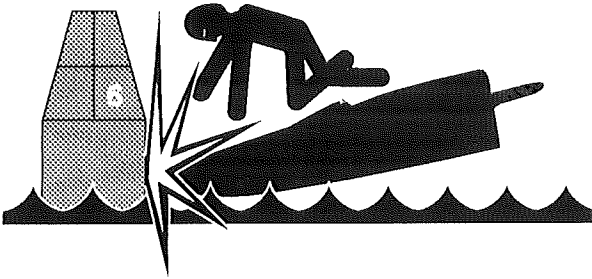

To maintain steerage you must maintain thrust. You will not be able to steer after shutting down the throttle or shutting off the engine. Keep the throttle on if you need to maneuver. Do not travel at high speed directly towards any object closer than 200'.

Place the shifter in NEUTRAL and shut off the boat's motor when you are still several feet from the person in the water. Once everyone is aboard, check that everyone is safely seated before restarting the motor. If you are unfamiliar with picking up swimmers in the water, practice this maneuver with a retrievable floating object before attempting it under actual conditions.

⚠ WARNING

Debris sucked into the jetdrive can be shot at high velocity from the jetdrive nozzle. Be sure no one is behind the boat who could be hit with flying debris. Being hit with flying debris can cause injury or death.

Boats have no brakes. Stopping is accomplished by backing down on the throttle. Once the boat has slowed and the motor is idling, place the shifter in REVERSE. Gradually increasing reverse power with the throttle will allow you to stop the boat in a very short distance. Note that a boat will not respond to steering in reverse nearly as well as it does when going forward, so do not expect to accomplish tight turning maneuvers when backing up.

In emergencies you can shift from forward to reverse at full throttle without causing mechanical damage. However, executing quick stops may eject the driver or passengers from the boat and possibly cause injury or death.

⚠ WARNING

The Reflexx is highly maneuverable, executing quick turns or stops may eject the driver or passengers from the boat possibly causing injury or death. Shifting from forward to reverse at high speed may cause the boat to be filled with water. If the boat fills with water be sure all the water has been pumped from the bilge before resuming normal operation or the engine may be damaged.

⚠ WARNING

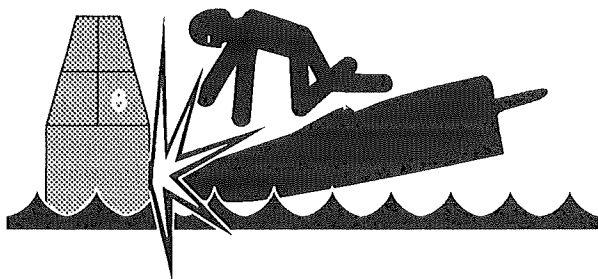

To maintain steerage you must maintain thrust. You will not be able to steer after shutting down the throttle or shutting off the engine. Keep the throttle on if you need to maneuver. Do not travel at high speed directly towards any object closer than 200'.

Once you are away from the dock, devote some time to learning how to maneuver.

- Practice docking by using an imaginary dock.
- Practice stopping and reversing (when moving in reverse, turning the wheel to the right will cause the stern to move to the left).
- When operating in close quarters or docking, all maneuvering should be done at idle speed. Proceed with caution in congested areas.
- Gradually increase your speed. Get used to the boat before attempting any full throttle operation.
- Do not run the boat in debris or weed filled waters. The jetdrive may become clogged causing unexpected loss of steerage and possible damage to the jetdrive.
- Do not run the boat in shallow water, the jetdrive may be damaged if foreign material is sucked into it.

⚠ CAUTION

Jumping waves exerts tremendous force against the boat which can over stress and damage the hull, deck and/or internal construction.

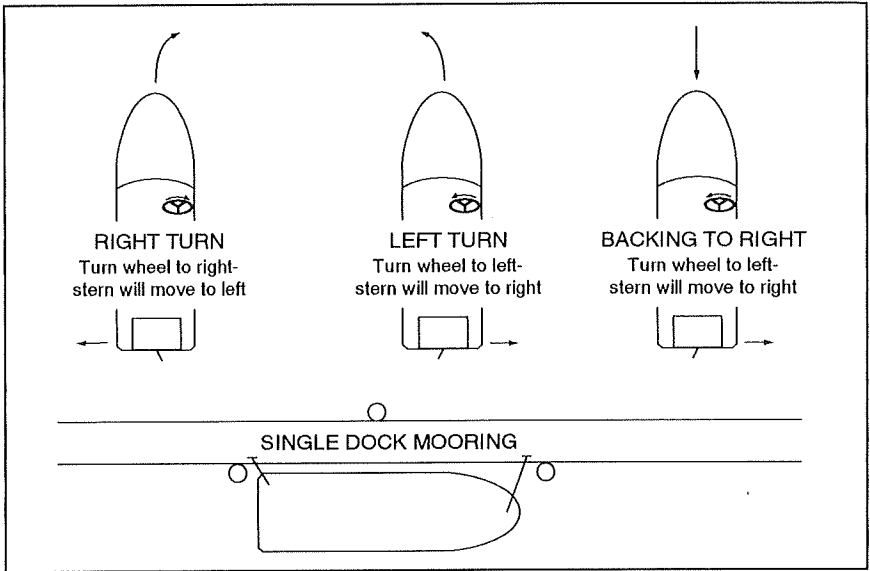

Docking

Preparation:

Proper docking requires preparation. Start by making sure you have adequate mooring gear, and that it is stowed correctly and ready for use. Your dealer is the best source for information concerning the amount and type of equipment you should carry.

Approaching the Dock:

When approaching a mooring area, lower your speed within a reasonable distance to allow your wake to subside before it reaches other boats or docks. As you get close to your moorage, check for any wind or current action that may affect your maneuver; then make a conservative approach with these factors in mind. Try to use the elements to your advantage. Allow them to carry the boat into the dock. If there are high winds or strong currents, it is best to approach the moorage against the wind or current, called the lee side. With a mild current and little or no wind, it is best to approach with the wind or current, called the windward side. While approaching, check to see that all lines are attached to the cleats on the side facing the moorage. Also insure that fenders are lowered on that side. Be sure to check that the fenders are hung at the proper height.

As you approach your moorage, it is desirable to have one person at the bow and one at the stern of the boat, each with a mooring line. Approach at idle RPM at an angle approximately 45 degrees to the dock. When the bow is within a few feet of the dock (starboard side) the stern can be brought alongside the moorage by turning hard to port. Next, at

idle RPM shift the boat into REVERSE. This will stop the boat and bring the stern even closer to the dock. These steps are reversed for docking to port.

Mooring:

To attach lines to deck cleats, tie or splice a loop in one end of the line and pass it through the hole in the base of the cleat; then pass the loop back over the entire cleat. The line can now be used to secure your boat.

⚠ WARNING

Whenever you are towing another boat, or having your boat towed, make sure the towline is fastened securely to the bow or transom towing eyes only. Never attach a towline to deck cleats as serious injury may result if the cleats pull free from the deck. Also, to reduce the danger created by a potential failure of the towline, everyone should stay well clear of the towline attachment points on both the towing and the towed boats.

Leaving the Dock:

Take into account wind, tide, current, and other forces that affect your maneuvering as you leave the dock. Most maneuvering to and from a dock is best accomplished at idle speeds.

Do not forget to release the mooring lines and stow the fenders.

When leaving a moorage on your starboard side and your bow cannot be pushed away from the dock first, start forward with the helm wheel turned to starboard for two or three feet. Then shift to REVERSE. Repeat if necessary to get the stern far enough away from the dock so you can back clear of any other boats that may be moored ahead of you. (Use opposite steering directions when departing a dock located to port.)

Clearing a Clogged Jetdrive

⚠ WARNING

Do not attempt any maintenance or adjustments to the motor or jetdrive unit while the motor is running. Failure to shut off the motor for maintenance or adjustments may cause injury or death.

If weeds or debris clog the jetdrive the foreign material must be completely cleaned out to return the unit to proper running order.

- Shut off the engine.
- Pull the lanyard disengaging the emergency engine shutdown switch.
- Remove the key from the ignition switch.
- Clean the entire jetdrive system (intake, impeller, nozzle, etc.) of foreign matter.
- If the jetdrive system cannot be easily cleared of debris the boat should be returned to the trailer or to a boat lift for haul out before further work is attempted.
- It may be necessary to remove the pump grate from the bottom of the boat to clear the jetdrive. If removal of the pump grate is necessary, consult the Engine Operator's Manual for proper removal and installation procedures.

If an object has become tightly wound around the impeller shaft it may be necessary to use the following procedure.

- Shut off the engine.
- Pull the lanyard disengaging the emergency engine shutdown switch.
- Remove the key from the ignition switch.
- Remove the spark plugs.
- Put a 1 1/16" wrench on the flywheel nut and turn the engine counterclockwise. As you turn the engine have someone slowly pull the object from the impeller shaft as it unwinds.

▲ CAUTION

Be sure all of the jetdrive components are completely free of debris. Cooling water for the motor is supplied through the jetdrive. Loss of engine coolant may cause overheating and damage the engine.

▲ CAUTION

Do not insert any object into the impeller area of the jetdrive as this may damage the unit.

Boat Performance

Boat speeds are affected by a great many factors. Some, such as temperature and altitude, you cannot change, but some factors you can:

1. **Loading:** Take only necessary equipment with you. Keep weight low in the boat and balanced.
2. **Weeds, barnacles and other growth:** Keep your boat's bottom clean. When your boat starts "growing grass", it will slow down greatly.

Boat Running Attitude

1. If your boat runs with its bow too high at cruising speeds, moving some weight forward in the boat will help you achieve a more correct cruising attitude.
2. If your boat runs with its bow too low at cruising speeds (usually indicated by water coming off the hull far forward and steering difficulty or veering off course), you can raise the bow by moving some weight aft.

Instruments

While under way, instruments should be checked frequently for possible indications of trouble.

1. *Fuel Gauge*—The fuel gauge indicates approximate fuel level. Since boats are exposed to rough water conditions and varying degrees of trim, it is usually not possible to fill the fuel tank to 100% of its dry-rated capacity. Therefore, fuel gauges may seem to provide inaccurate readings at times. It is always good to keep track of the amount of fuel you pump aboard, as well as your running time and estimated fuel usage as a double check against an inaccurate gauge. Be sure to follow the recommended fueling procedures in the operating section of this manual.

COMPONENTS/SYSTEMS

Electrical System

DANGER

Knife switches or other arcing devices should never be installed in fuel compartments.

DANGER

Never substitute automotive parts for marine parts. Electrical, ignition and fuel system parts on your Maxum are designed and manufactured to comply with U.S. Coast Guard Rules and Regulations to minimize risks of fire and explosion.

WARNING

To reduce the risk of fire or explosion only qualified personnel should install batteries and perform electrical system maintenance. You can minimize the danger of fire and explosion by not exposing the batteries to open flame or sparks. It is also important that no one smoke anywhere near the batteries. Because fuel fumes are heavier than air, they will collect in the bilge areas where they can be accidentally ignited. Operating the bilge blower for at least four minutes prior to engine starting, electrical system maintenance, or activation of electrical devices will decrease the danger of fire and explosion.

NOTICE

Electrical connections are susceptible to corrosion. To help prevent electrical malfunction due to corrosion, keep all exposed electrical connections clean and protect them with a good quality spray-on protectant such as *Corrosion Guard*®.

Although Bayliner manufactures many different models of powerboats, the electrical systems on all models operate on the same basic theory.

1. *Battery:*

The key to a good marine electrical system is the battery (the battery is a dealer-installed item). Bayliner makes the following recommendations on battery rating:

Jet Drive Models — 550 cold cranking amps minimum

Check the battery electrolyte level regularly. Remove the caps on top of the battery and observe the level of the fluid inside. If the zinc plates are exposed, add distilled water until they are covered again. Corroded terminals can impair battery performance and charging ability. Clean them with baking soda and water; then coat them with a preservative or a light film of grease. Be sure all battery connections are tight. When storing the boat, it is best to remove the battery, give it a full charge, and store it inside away from extreme temperatures. **Note that you should never disconnect battery cables while the engine is running, as this can cause damage to your boat's electrical components.**

2. *Fuses and Circuit Breakers:*

The engine circuit is protected by a circuit breaker located on the engine while the accessory circuit is protected by an in-line fuse located at the battery. In addition, a fuse block for branch accessory circuits is located under the helm. Wires are color coded to indicate which accessory each fuse services. Some items, such as bilge pumps, may be fused individually at the unit. Auto float switches are fused at the battery. A wiring diagram is provided at the back of this manual.

Starter Motor

The engine starter motor is designed to deliver high horsepower for only very short periods of time. Avoid operation for more than 15 seconds at a time. Allow at least three minutes for cooling between start attempts. Due to its high horsepower, this motor builds up considerable heat and can be permanently damaged with prolonged use. If it does not operate, check the battery charge and all direct wiring for shorts or loose connections. The starter can be damaged if excess bilge water is allowed to come in contact with it. Automatic bilge pumps are recommended for boats left in open moorage.

Bilge Blower

A bilge blower is provided that removes fumes from the engine compartment and draws fresh air into the compartment through the deck vents.

To insure fresh air circulation, the bilge blower is to be used before starting the engine, during starting, and while the boat is operating below cruising speed. Operate the blower for at least four minutes before starting the engine.

WARNING

Operation of the blower is NOT A GUARANTEE that explosive fumes have been removed. If you smell any fuel, shut off the engine and all electrical accessories and investigate immediately.

Bilge Pump

The electric bilge pump supplied with your boat is an impeller-type pump. It is controlled by a switch on the dash panel, which should be activated whenever water begins to accumulate in the bilge. Your boat will also have an automatic bilge pump switch ("autofloat switch") mounted next to the pump. This is a float-type switch that will activate the bilge pump automatically whenever bilge water accumulates above a pre-set level. It is wired directly to the battery so it will normally function even when the boat is completely shut down and unattended, such as when the boat is moored at a marina.

Operation of the bilge pump should be checked frequently. To check the bilge pump, activate the dash-mounted switch and verify that bilge water is being pumped overboard. If bilge water is present and the pump motor is running but not pumping, check to see if the pump is clogged with debris. Squeeze the two holding tabs on the side of the pump housing inward and pop the pump's upper housing off. If the pump's strainer well is clear but the pump still does not move water, check the discharge hose for kinks or a collapsed area.

The autofloat switch should also be checked frequently for proper operation.

Switches with housings:

- Squeeze the two holding tabs on the side of the switch housing inward and pop the upper housing off to gain access to the float. Remove any debris you find in the strainer well.

All switches:

- Raise the float to verify it has full up and down movement. As you raise the float to its full upward position, the bilge pump should turn on and empty bilge water overboard. If raising the float does not switch the pump on, check the in-line fuse in the wire between the switch and the battery and make sure it has not blown. If the fuse is good, but the switch still does not work, it usually indicates a bad switch, or possibly a low battery. In either case, call your dealership for further assistance.

NOTICE

The Federal Water Pollution Control Act prohibits the discharge of oil or oil waste into or upon the navigable waters and contiguous zone of the United States if such discharge causes a film or sheen upon, or discoloration of, the surface of the water, or causes a sludge or emulsion beneath the surface of the water. Violators are subject to a penalty of \$5000.

Navigation Lights

Vessels are required to have navigation lights turned on from "dusk to dawn" or in conditions of reduced visibility. It is wise to run at reduced speed whenever navigation lights are needed. Although the navigation lights supplied with your Bayliner are of top quality, failure may occur for a variety of reasons:

1. There may be a blown fuse. (Replace the fuse in the fuse block.)
2. The bulb may be burned out. (Carry spare bulbs for replacement.)
3. The bulb base may be corroded. (Clean the base periodically and coat it with nonconductive grease.)
4. A wire may have come loose or may be damaged. (Repair as required.)

Fuel System

CAUTION

It is very important that the fuel system be thoroughly inspected for leaks the first time it is filled and then at each subsequent filling. For your safety and the safety of your passengers, the fuelling instructions in this manual must be followed.

1. *Fuel Fills and Vents:*

The fuel fill is located on the forward starboard deck. Fuel receptacle caps are marked "Fuel" or "Gas". Fuel vents are normally located below and in the same general area as the fill. If you experience difficulty filling the fuel tank, check to see that the fuel fill and vent lines are free of obstructions and kinks.

N O T I C E

If an engine running problem is diagnosed as fuel starvation, the antisiphon valve should be checked. In the event the valve is stuck or clogged, it should be cleaned or replaced while the engine is shut down. Under no circumstances should it be removed except in an emergency.

3. *Fuel Filters:*

All fuel tanks are equipped with a fine mesh screen filter on the fuel pick-up tube in the tank. In addition, when supplied by the motor manufacturer, an additional filter is installed on the engine. Fuel filters should be checked periodically to see that they are clean and free of debris.

C A U T I O N

Avoid the storage or handling of gear near the fuel lines, fittings and tank.

GENERAL MAINTENANCE AND REPAIRS

In addition to instructions found elsewhere in this manual and in the literature specific to certain components, the following information is provided for general maintenance and repair.

Because conditions vary widely in different areas, and the frequency and type of use can differ greatly between owners, intervals for maintenance are not listed here. Common sense should determine the frequency of maintenance. If you are using your boat in salt water it is highly recommended that the engine and the electrical connections on the back of the instrument are sprayed liberally with Corrosion Guard. This product is available from your US Marine dealer - Mercury Marine, part number 92-815869A1.

Bilges/Engine Compartment

1. Pump the bilges dry and remove all loose dirt. Be sure that all limber holes are open. If there is oil in the bilge and the source is not known, look for leaks in engine oil lines or engine gaskets. Oil stains can be removed by using a bilge cleaner available from your dealer or a marina. **DO NOT** use flammable solvents.
2. Check all wiring to be sure it is properly supported, that its insulation is intact, and that there are no loose or corroded terminals. If there are corroded terminals, they should be replaced or thoroughly cleaned. Tighten all terminals securely and spray them with light marine preservative oil.
3. Inspect the entire fuel system (including fill lines and vents) for any evidence of leakage. Any stains around joints could indicate a leak. Try a wrench on all fittings to be sure they are not loose, but do not overtighten them. Clean fuel filters and vent screens.
4. Inspect the entire bottom for evidence of seepage, damage or deterioration, paying particular attention to hull fittings, hoses and clamps. Straighten kinked hoses and replace any that do not feel pliable. Tighten loose hose clamps and replace those that are corroded. Tighten any loose nuts, bolts or screws.
5. Refer to your sport jet operator's manual for engine and jet drive maintenance details. Wipe off the engine to remove accumulated dust and grease. If a solvent is used, make sure it is nonflammable. Go over the entire engine and tighten nuts, bolts, and screws. Inspect the wiring on the engine and clean and tighten the terminals. Clean and lubricate the battery terminals; fill the battery cells with distilled water as needed.

Topside Areas

1. Check cleats and grab rails for loose screws, breaks, sharp edges, etc., that might be hazardous in rough weather. Inventory and inspect life jackets for tears and deterioration. Check your first aid kit to make sure it is complete. Check the signaling equipment. Inspect anchor, mooring and towing lines and repair or replace as required. **DO NOT** stow wet lines or they may mildew and rot.
2. Stainless steel fittings should be cleaned with soap and water or household glass cleaner. Because irreversible pitting will develop

under rust that remains on stainless steel for any period of time, it is best to remove rust spots immediately with brass, silver or chrome cleaner. Then coat the fitting with a good automobile or boat wax. Never clean with mineral acids or bleaches. Also, do not allow stainless steel to come into continuous contact with iron, steel or other metals which could cause contamination leading to rust or corrosion.

3. Exterior fabrics should be cleaned with a sponge or very soft scrub brush and a mild soap and warm water solution. Rinse after scrubbing with plenty of cold, clean water and allow the fabric to air dry in a well ventilated place, preferably away from direct sunlight.

Mildew can occur if your boat does not have adequate ventilation. Heat alone will not prevent mildew; you must also provide for fresh air circulation. If mildew does occur, it often can be removed using a solution of warm water and laundry bleach (one cup of bleach to one gallon of warm water). Brush the solution into the affected area, let it sit for 10 to 15 minutes, and rinse with plenty of cold, clean water. Air dry in a well ventilated place, once again preferably away from direct sunlight.

4. When instruments are exposed to a saltwater environment, salt crystals may form on the bezel and the plastic covers. These salt crystals should be removed with a soft, damp cloth; never use abrasives or rough, dirty cloths to wipe plastic parts. Mild household detergents or plastic cleaners can be used to keep the instruments bright and clean.

Hull

1. The finish on a fiberglass boat is similar to that of an automobile and will respond to the same system of care and cleaning.

Use a sponge and a mild soap and warm water solution to clean exterior surfaces of your boat. Rinse the boat well with plenty of clean water. You can use either boat or automobile wax to protect the finish. Note that there are a variety of polishes and cleaners for fiberglass on the market. We suggest that you experiment with different brands to determine which work best for you.

2. Almost unavoidable during the life of your boat is damage to the gelcoat or colored surface. This is not as serious as you might think. Repair is not costly and can be done by the novice.

Scratches: If the scratch does not penetrate the gelcoat surface, it can be repaired with automotive rubbing compound. Dampen a soft rag and apply the compound by rubbing in a circular motion. The scratch may not disappear completely; however, its noticeability will decrease.

Gouges and Chips: To repair, obtain "patch paste" from your Bayliner dealer and follow this recommended procedure:

- Clean the area to be repaired of wax and oil. Acetone is a good solvent.
- Mix a small portion of patch paste and catalyst on a piece of cardboard according to the manufacturer's instructions.
- Apply the paste to the gouge with a putty knife or flat-edged stick; try to match the paste to the surface contour of the area being repaired. It is better to have an excess of paste, rather than not enough.
- Allow the paste to harden thoroughly. In most climates, one to two hours should be sufficient.
- Shape the patch as desired using fine wet sandpaper.
- Finish by using automotive rubbing compound in the same manner as you did for small scratches.

WARNING

Acetone and catalyst are hazardous materials and should be used only in well ventilated areas. Follow the manufacturer's instructions. Also, never store rags that have been wetted with acetone, fuel or any other solvent aboard your boat. Immediately remove them from the boat and discard them to prevent spontaneous combustion and fire.

3. Special Care for Boats That Are Moored

If permanently moored in saltwater or fresh water, your boat will collect marine growth on its bottom. This will detract from the boat's beauty and greatly affect its performance. There are two methods of preventing this:

- Periodically haul the boat out of the water and scrub the bottom with a bristle brush and a solution of soap and water.

- Paint the hull below the waterline with a good grade of antifouling paint. **DO NOT** paint the jetdrive surfaces.

N O T I C E

Bayliner recommends the application of an epoxy barrier coating, such as International Paint Company's Interlux "Interprotect 2000 System", to help seal the hull bottom and reduce the possibility of gelcoat blistering on any boat that is permanently moored. The barrier coating should be covered with several coats of antifouling paint. Note that many states regulate the chemical content of bottom paints in order to meet environmental standards. Check with your local Bayliner dealer about recommended bottom paints, and about laws that are in effect in your area.

4. Whenever your boat is out of the water you should check all metal parts for stray current corrosion. Stray current corrosion, or electrolysis, can be prevented several ways. The following are the most common causes and the simplest cures:
 - Wiring may leak a certain amount of electricity. Keep a clean, dry bilge.
 - A poorly grounded zinc anode: Check the ground wire and clean all contact surfaces.
 - The zinc anode may be deteriorated beyond effectiveness. Replace it when it has deteriorated 50% or more.
 - If your boat is permanently moored, we recommend that you contact someone in your area specializing in corrosion control and have them check your boat in its moorage to see that it is properly protected.

STORAGE

The following suggestions are offered for storage at the end of your boating season.

1. Your boat should be stored under cover if possible. If covered storage isn't available, a temporary winter cover is recommended. A proper winter cover should keep weather off the boat, but still provide adequate ventilation. Wrapping a boat up in a tight plastic cover can do more damage than good. Dampness and lack of air circulation provide ideal conditions for fungi that cause mildew and dry rot.

2. If you are storing your boat on its trailer:
 - Now is a good time to repack the trailer's wheel bearings. Your local auto service center can help you.
 - Block the trailer wheels off the ground to avoid tire deterioration.
 - Loosen the stern tie-downs to avoid stress on the hull.
3. Refer to your sport jet operator's manual for sport jet storage instructions.
4. Remove the marine battery from the boat. Fill the cells to the proper level and store your battery in a warm place. A fully charged battery will survive storage better.
5. Fuel tanks should be filled so there is little air space, thereby minimizing condensation.
6. Thoroughly clean your boat. If possible, remove cushions, mattresses, blankets, towels, and other items that can hold moisture and cause mildew. Such items left on board should be positioned for maximum air circulation. Prop open hatches to allow fresh air to circulate.
7. Clean all deck hardware; then coat the hardware with rust inhibitor.
8. Lubricate the steering mechanism and throttle control linkage.

We hope these preventive measures will help make getting ready again in the spring easier. Should you have any questions, your Bayliner dealer is eager to provide assistance.

NAUTICAL TERMS

ABEAM:	To one side of a vessel, at a right angle to the fore-and-aft line.
AFT:	Near or at the stern.
BEAM:	The width of the hull.
BILGE:	The lowest portion inside a boat (in a fiberglass boat, generally the underdeck and lower portion of the engine compartment).
BOW:	The forward portion of the boat.
CHINE:	The intersection of the side and bottom of a V-bottom boat.
DRAFT:	Vertical distance from the waterline of the boat to the lowest point of the boat.
FATHOM:	A measurement of six feet, generally used to measure water depth.
FREEBOARD:	Vertical distance from the deck to the waterline.
GUNWALE:	The upper edge of the side of a boat.
HATCH:	A deck opening providing access to the space below. Normally fitted with a cover.
HELM:	The tiller, wheel, and other steering gear.
KEEL:	The lowest external portion of the hull.
KNOT:	Nautical mile per hour; one nautical mile is 6,076 ft.; a land mile is 5,280 ft.
LEE:	The direction toward which the wind blows.
PORT:	To the left side of the boat facing forward.
SCUPPER:	An opening in a deck or cockpit permitting water to drain overboard.
STARBOARD:	To the right side of the boat facing forward.
STERN:	The after portion of the boat.
JETDRIVE:	Propulsion unit using thrust.
THRUST:	The reaction force produced by a high-speed jet of fluid.
TRANSOM:	The transverse part of the stern.
WINDWARD:	The direction from which the wind is blowing.

WARNING LABELS

The location of the warning labels on your boat and an example of each is shown below. Warning labels should be replaced if damaged, removed or lost. Replacements can be ordered through your dealership.

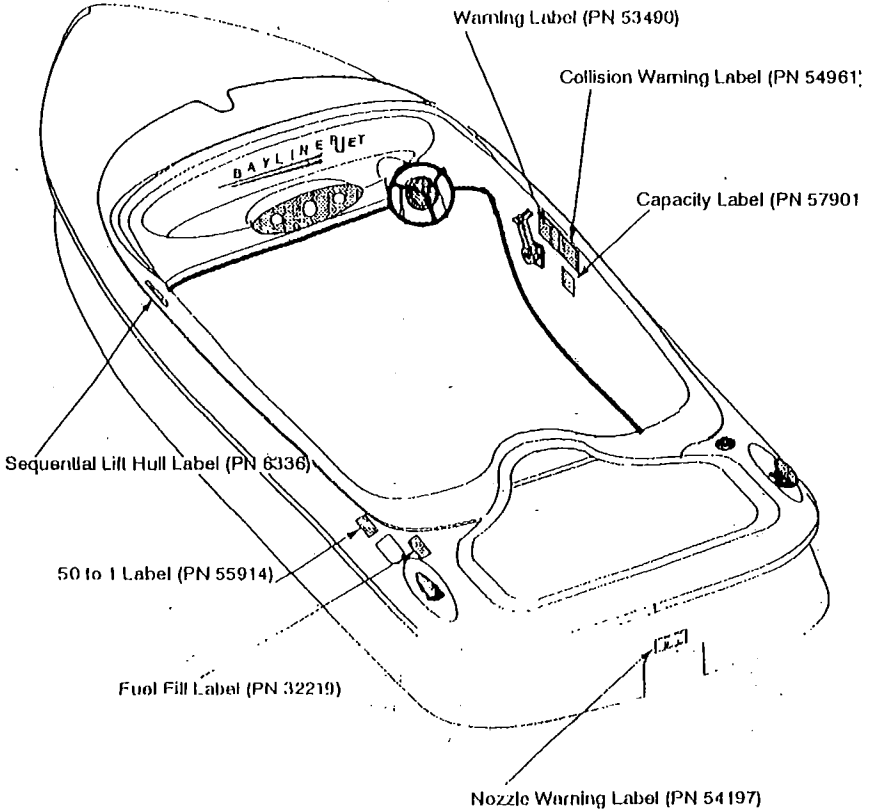

⚠ WARNING	⚠ WARNING	⚠ NOTICE
EMERGENCY SHUTDOWN SWITCH LANYARD MUST BE ATTACHED TO OPERATOR WHILE THE ENGINE IS IN OPERATION	QUALIFIED OPERATOR TO BE IN CONTROL AT ALL TIMES. READ OWNER'S MANUAL BEFORE USE.	THIS BOAT COMPLIES WITH U.S. COAST GUARD SAFETY STANDARDS IN EFFECT ON DATE OF CERTIFICATION. BAYLINER MARINE ARLINGTON, WA

53490

P/N 53490

WARNING

- 1) USE GASOLINE ONLY. GASOHOL OR OTHER FUEL ADDITIVES MAY DAMAGE FUEL SYSTEM.
- 2) LEAKING FUEL IS A FIRE AND EXPLOSION HAZARD. INSPECT SYSTEM AT LEAST ANNUALLY
- 3) MIX GASOLINE (85 OCTANE MIN.) WITH OUTBOARD MOTOR OIL IN 50:1 RATIO (1 PINT/6 GAL. U.S.), DOUBLE OIL MIX DURING BREAK-IN PERIOD.

32220

P/N 32220

U.S. COAST GUARD MAXIMUM CAPACITIES

4 PERSONS OR 600 LBS

700 LBS PERSONS, GEAR

JB

5/93 57901

P/N 57901

	<p>⚠ CAUTION</p> <p>Sharp edges.</p> <p>Sharp edges on the jet nozzle can cut or pinch.</p> <p>Keep hands and feet away from the jet nozzle,</p> <p>P/N 54197</p>
---	---

P/N 54197

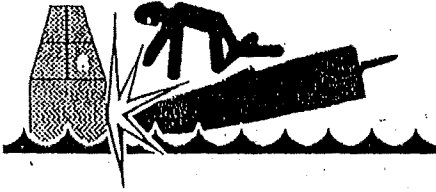
	<p>⚠ WARNING</p>
--	-------------------------

P/N 54961

SEQUENTIAL LIFT HULL®

P/N 6336

**50:1 RATIO
GAS OIL MIX**

P/N 55914

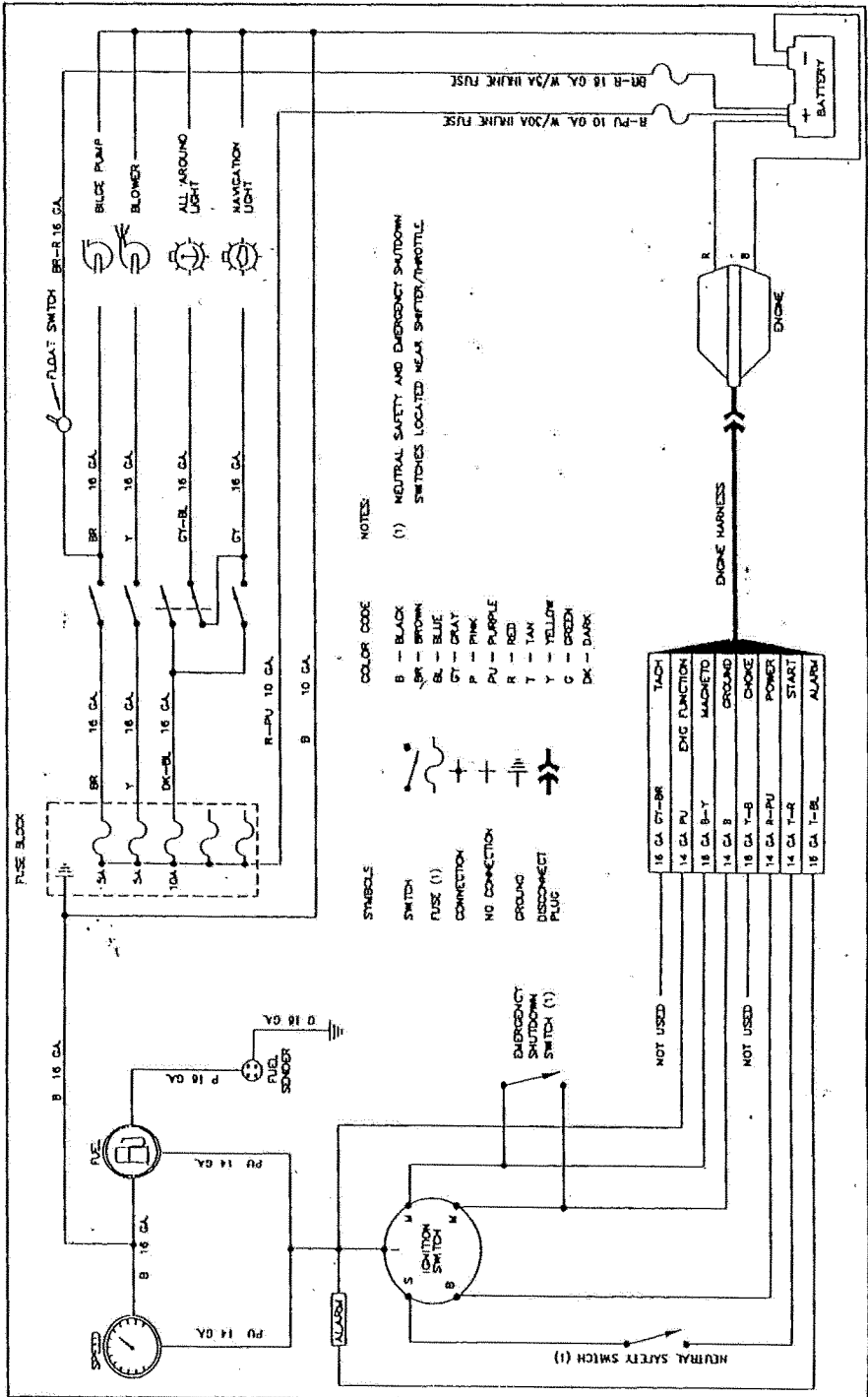

LIMITED WARRANTY

Bayliner warrants to the original purchaser of its 1995 Reflexx boats, purchased from an authorized dealer, operated under normal, noncommercial use that the Selling Dealer will:

- A. Repair any structural hull defect which occurs within five (5) years of the date of delivery.
- B. Repair or replace any parts found to be defective in factory material or workmanship within one (1) year of the date of delivery.

What Is Not Covered

This warranty does not apply to:

- 1. Engines, drive trains, controls, impellers, batteries, or other equipment or accessories carrying their own individual warranties;**
- 2. Engines, parts or accessories not installed by US Marine;**
- 3. Minor gelcoat discoloration, cracks or crazing or air voids;**
- 4. Hull blisters that form below the waterline;**
- 5. Normal deterioration, i.e. wear, tear, or corrosion of hardware, vinyl and fabric upholstery, plastic, metal, wood, or trim tape;**
- 6. Any Bayliner boat which has been overpowered according to the maximum horsepower specifications;**
- 7. Any Bayliner boat used for commercial purposes;**
- 8. Any defect caused by failure of the customer to provide reasonable care and maintenance.**

Other Limitations

THERE ARE NO OTHER EXPRESS WARRANTIES ON THIS BOAT. TO THE EXTENT ALLOWED BY LAW:

- 1. Any implied warranty of merchantability is limited to the duration of this written warranty.**
- 2. Neither Bayliner nor the Selling Dealer shall have any responsibility for loss of use of the boat, loss of time, inconvenience, commercial loss or consequential damages.**
3. Some states do not allow limitations on how long any implied warranty lasts, so the above limitation may not apply to you. Some states do not allow the exclusion or limitation of incidental or consequential damages, so the above limitation or exclusion may not apply to you. This warranty gives you specific legal rights, and you may also have other rights which vary from state to state.

Your Obligation

In order to comply with Federal regulations, it is essential that your warranty registration card be submitted within 30 days of delivery of your boat. Return of this card is a condition precedent to warranty coverage. Before any warranty work is performed, we require that you contact your Selling Dealer to request warranty assistance.

We require that you return your boat, at your expense, to your Selling Dealer or, if necessary, to the Bayliner factory. You will be responsible for all transportation, haulouts and other expenses incurred in returning the boat for warranty service.

**Bayliner Marine Corporation
PO Box 9029
Everett, WA 98206
Phone (206) 435-5571**