

BAYLINER®

OWNER'S MANUAL

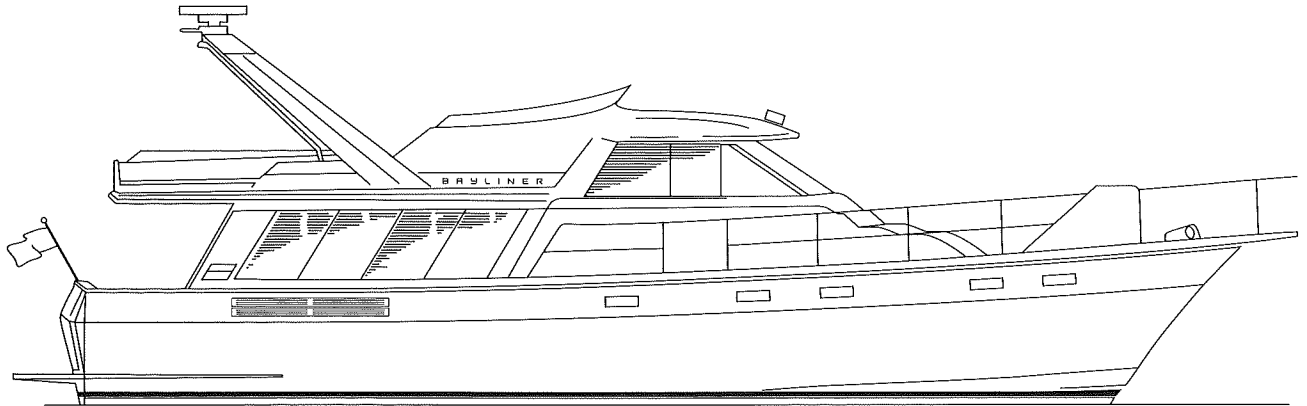

4588 PILOTHOUSE MOTORYACHT

THE WORLD'S NUMBER ONE PLEASURE BOAT BUILDER!

Table of Contents

WELCOME ABOARD	3
PREPARATION	3
Recommendations for Safety	3
Safety Equipment	5
Tool Chest	5
Miscellaneous Items	5
Static Float Attitude	6
Other Tips	6
OPERATING	6
Fueling Procedures	6
Prestart Inspection	7
Starting Procedure	7
Engine Idling Inspection	8
New Engine Break-in	8
Before You Leave	9
Maneuvering	9
Boat Performance	11
Boat Running Attitude	11
Trim Tabs	11
Instruments	11
Dual Station Operation	12
Structural Limitations	12
Engine Shut-Down	12
COMPONENTS/SYSTEMS	13
Electrical System (12-Volt DC)	13
Electrical System (110-Volt AC)	14
Diesel Generator	15
Hot Water Heaters	15
Air Conditioning/Heating	15
Anchor Windlass	15
Davit	16
Fuel System	16
Shaft-Transmission Alignment	16
Shaft Log Stuffing Box Packing	17
Rudder Stuffing Gland	17
Stove	17
Steering	17
Spotlight	17
Refrigerator	18
Seawater Strainers	18
Exhaust System	18
Potable Water System	18
Marine Head System	18
Trash Compactor	19
Bilge Pumps	19
Washdown System	19
Washer/Dryer	19
Radar	20
Autopilot	20
Stereo	20
Depth Sounder	20

Table of Contents (Con't.)

GENERAL MAINTENANCE AND REPAIRS	20
Bilges/Engine Compartment	20
Cabin and Topside Areas	21
Hull	22
STORAGE	24
NAUTICAL TERMS	25
ILLUSTRATIONS	26
WIRING DIAGRAMS	32
WARRANTY	34

The hazard warning symbols shown below are used throughout this manual to call attention to potentially dangerous situations which could lead to either personal injury or product damage. We urge you to read these warnings carefully and follow all safety recommendations.

DANGER

The symbol shown above alerts you to immediate hazards which **WILL** cause *severe personal injury or death* if the warning is ignored.

WARNING

The symbol shown above alerts you to hazards or unsafe practices which **COULD** result in *severe personal injury or death* if the warning is ignored.

CAUTION

The symbol shown above alerts you to hazards or unsafe practices which **COULD** result in *minor personal injury, or cause product or property damage* if the warning is ignored.

NOTICE

The symbol shown above calls attention to installation, operation or maintenance information which is important to proper operation, but is not hazard-related.

WARNING

A qualified operator must be in control of the boat at all times. Do not operate your boat while under the influence of alcohol or drugs. Never operate your boat at speeds which exceed your ability to react if an emergency develops. At night, turn on the appropriate running lights and cruise at a reduced speed that will allow you plenty of time to avoid dangerous situations.

Welcome Aboard

This manual has been prepared to assist you in the operation and care of your **Bayliner 4588 Motoryacht**. Please read through it completely, as familiarization with its contents can contribute to the safe and effective operation of your yacht.

Your Motoryacht's engines and accessories were selected to provide optimum performance and utility. Installation of different engines or other accessories may cause undesirable handling characteristics. Should you choose to install different engines, or to add accessories that will affect the boat's running trim, have an experienced marine technician perform a safety inspection and a handling test before operating your yacht by yourself again.

Your yacht's mechanical and electrical systems were designed to meet safety standards in effect at the time it was constructed. Some of these standards were mandated by Federal law, others are considered industry norms. All of them were designed to insure your safety, and the safety of other people, vessels and property around you. **To maintain the integrity and safety of your yacht, only qualified people should perform maintenance on, or in any way modify, the steering system, propulsion system, engine control system, fuel system, environmental control system, or electrical system.** Failure to maintain these systems as designed could violate Federal law, and could expose you and other people to the danger of bodily injury or accidental death. We recommend that you follow the instructions provided in this handbook, in the engine owner's manual, and in the accessory instruction sheets included with your yacht. We also recommend that you perform the following steps:

1. Make certain that you receive a full explanation of all systems from the dealer before taking delivery of your yacht. Your selling dealer is your key to service. If you experience any problems with your new Bayliner, immediately contact the dealership. If for any reason your selling dealer is unable to help, call us direct on our customer service hotline for assistance. The number is (206) 435-8957.
2. Read this manual thoroughly, paying particular attention to the subjects of **fueling, checking for fumes, starting, carbon monoxide, loading limits, trim tabs, recommendations for safety, and warranty.**
3. Practice—all members of the family should be familiar with the operation and systems of your yacht.
4. Participate in a safe boating course. Call the local office of the United States Power Squadrons or the United States Coast Guard Auxiliary for the date and location of their next class.

PREPARATION

Prior to leaving on your first outing (or, for that matter, any outing) there are certain items to check and activities to perform. Beside reading this manual and your engine manual, familiarize yourself with your yacht while dockside, and consider the following suggestions:

Recommendations for Safety

1. Personal Flotation Devices:
One Coast Guard approved personal flotation device (PFD) of suitable size is required for each person aboard recreational boats. New PFDs bearing Coast Guard approval are now identified as Type I, II, III, or IV.

Boats sixteen feet (16') or over in length: One (1) Type I, II, or III (wearable PFD) for each person on board, and one (1) Type IV (throwable PFD) in each boat.
2. Always have children wear lifesaving devices. Always check those devices intended for young children for fit and performance in the water. Never hesitate to have all hands wear lifesaving devices whenever circumstances cause the slightest doubt about safety.

3. Do not overload or improperly load your boat. Maintain adequate freeboard at all times. Consider the sea conditions, the duration of the trip, the weather and the experience of the personnel on board.
Do not allow anyone to ride on parts of the boat that were not designed for such use. Sitting up on seat backs, bow riding, gunwale riding, or lounging on forward sundeck cushions while underway can be especially hazardous.
4. Falls are the greatest cause of injury both afloat and ashore. Eliminate tripping hazards wherever possible, make conspicuous those that must remain, and require that all persons on board wear proper footwear.
5. Understand the meanings of navigation buoys, and never moor to one. (It is a federal offense.)
6. Know the various distress signals. A recognized distress signal used on boats is to slowly and repeatedly raise and lower the arms outstretched to each side.
7. Check the weather forecast for your area and plan accordingly.
8. A special flag (red flag with a white diagonal stripe or white and blue Alpha signal flag) flown from a boat or buoy means skin diving operations are underway nearby. Approach with caution and stay clear by at least 25 yards.
9. Make sure your boat's engines are shut down before allowing people to swim to or from your boat, or to swim anywhere near your boat. Before lowering the transom boarding ladder, shut both engines OFF and remove the keys from the ignition switches so that nobody will accidentally start the engines while swimmers are nearby. Also, slow down and exercise extreme caution any time you are cruising in an area where there might be swimmers or water skiers in the water.
10. Watch your wake. It might capsize a small craft. You are responsible for damage caused by your wake. Pass through anchorages at minimum speed.
11. Learn and abide by common boating "rules of the road".
12. Always have up-to-date charts of your cruising area on board.
13. Keep an alert lookout. Serious accidents have resulted from failure in this respect.
14. Always instruct at least one person on board in the rudiments of boat handling in case you are disabled or fall overboard.
15. Consider what action you would take under various emergency conditions such as a person overboard, fog, fire, a damaged hull or other bad leaks, motor breakdown, severe storm or collision.
16. If you ever capsize, remember that if the boat continues to float, it is usually best to remain with it. You are more easily located by a search plane or boat.
17. Keep firefighting and lifesaving equipment in good condition and readily available at all times.
18. Do not test fire extinguishers by squirting small amounts of the agent. The extinguisher might not work when needed. Always follow approved instructions when checking fire extinguishers.
19. Have an adequate anchor and sufficient line to assure a secure hold in all types of weather and sea conditions.
20. Boat hooks are valuable when docking or when needed to retrieve objects that have fallen overboard.
21. Keep electrical equipment and wiring in good condition. No knife switches or other arcing devices should be installed in fuel compartments. Allow ample ventilation around batteries.
22. Good housekeeping is even more important afloat than ashore. Cleanliness diminishes the probability of fire.
23. Know your fuel tank capacity and cruising range. If it is necessary to carry additional fuel, do so only in proper containers.
24. Before departing on a boat trip, you should advise a responsible friend or relative about where you intend to cruise. Be sure to give that person a good description of your boat. Keep them advised of any changes in your cruise plans. These precautions will enable your friend or relative to tell the Coast Guard where to search for you and what type of boat to look for if you fail to return. Be sure to advise the same person when you complete your trip to prevent any false alarms about your safety.

25. Your local United States Coast Guard Auxiliary and the United States Power Squadrons offer safe boating classes several times a year. These are comprehensive courses, and are generally of minimal cost to you. Call your local U.S. Coast Guard Auxiliary or Power Squadron Flotilla for the time and place of their next class.

Remember these are recommendations only. Check with the proper authorities for the exact safety requirements for your area.

Safety Equipment

The following safety-related items should be considered as part of your standard equipment:

1. Fire extinguishers (correct number and type, unexpired, located for easy access)
2. Personal flotation devices
3. Fenders, lines and boat hook
4. Flares (unexpired night and day type)
5. Flashlight(s) with extra batteries
6. Charts of your intended cruising area
7. First aid kit
8. Anchor and adequate scope of line

Tool Chest

1. Assorted screwdrivers (Phillips and flat blade)
2. Pliers (regular, vice-grip, and water pump)
3. Wrenches (box, open-end, allen, and adjustable)
4. Socket set (metric and U.S. standard)
5. Hacksaw with spare blades
6. Hammer
7. Battery jumper cables
8. Electrical tape
9. Assorted fasteners
10. Gear grease and penetrating oil
11. Feeler gauges

Miscellaneous Items

1. Engine and accessories manual
2. Spare propeller with fastening hardware
3. Propeller shaft packing material
4. Spare propeller shaft and strut
5. Extra V-belts
6. Engine lubricating oil
7. Transmission fluid
8. Spare fuel and oil filters
9. An extra cooling pump impeller
11. Replacement light bulbs

Static Float Attitude

The static floating attitude of your boat can be affected by many variables. Optional equipment and loading of gear are the biggest contributors to a boat's list. After launching, the floating attitude of any new boat can be adjusted. If your boat lists to one side, load heavy items on the opposite side until the boat floats more level. Load the remainder of your gear evenly after that.

Other Tips

1. When commissioning a new boat, do not plan an extensive trip or party until you have taken a shakedown cruise to make sure all equipment on your boat is functioning properly and you are familiar with its operation.
2. Use big fenders or fender boards to protect your yacht's hull whenever mooring next to floats, piers or other boats.
3. Carry plenty of line properly sized to your boat. We suggest at least four 60' lengths of 5/8" nylon line.

OPERATING

Fueling Procedures

WARNING

Fuel vapors are explosive and can become trapped in the lower portions of a boat where they might be ignited accidentally. While fueling your yacht, all doors, hatches, and portlights must be closed.

To fuel your yacht:

1. Be sure that your yacht is securely moored to the dock.
2. Turn off all electrical equipment, including engines, generator, appliances, bilge blower, lights, etc.
3. Extinguish all cigarettes, cigars or other items that may produce a spark or flame.
4. Close all openings including hatches, windows, doors and portlights.
5. Through-deck fittings for fuel tank filling are found on both the port and starboard sides, approximately midway between the bow and stern, and are labeled DIESEL. Remove the cap and insert the diesel supply nozzle, allowing the nozzle to maintain contact with the fitting; this will prevent possible static sparking.
6. After about 10 gallons have been pumped into a tank, inspect the engine and tank area for signs of fuel leakage. Proceed with fueling if no problems are detected.
7. Often you won't be able to fill the fuel tanks to 100% of their dry-rated capacity. This is because the amount of fuel each tank will hold depends, in part, on the boat's floating attitude, which in turn affects the position of the fuel tank and its venting system. If fuel flows out the tank vent on the side of the boat, discontinue fueling that tank immediately. The tank will be as full as possible under the current conditions. It is advisable not to overfill the tanks as you want to allow for thermal expansion of the fuel, especially on very hot days.
8. If, when filling the tanks, you can't put fuel in at a reasonable rate, check the fuel vent line for that tank to see that it's not kinked or plugged.
9. When you have finished fueling, replace the fill cap and wash off any fuel spillage.

10. Open the engine compartment and all windows, doors, and hatches; inspect, both visually and by smell, for fuel fumes or leakage. Any sign of fuel leakage, or any indication of fumes, must be investigated and corrected prior to starting the engine.
11. Operate the bilge blower for at least four minutes prior to starting the engines. Leave the blower on until the boat is underway and up to cruising speed.

Prestart Inspection

An operation and maintenance manual for your diesel engines is included with your motoryacht. Prior to initial operation you should carefully read the contents of that manual.

Before starting the engines, check the following:

1. Fuel fumes
2. Engine oil level
3. Coolant level

WARNING

To prevent severe burns or personal injury, DO NOT remove the heat exchanger caps while the engines or their cooling systems are hot.

4. Fuel level
5. Transmission oil level
6. Check that the fuel supply valves are open
7. Check that the seawater intake valves (seacocks) are open
8. Visually inspect the water separators for moisture or contamination
9. Visually inspect the seawater strainers for debris
10. Check all V-belts for correct tension
11. Visually inspect for indications of fuel, oil, coolant and exhaust leaks

Starting Procedure

1. Turn the battery switch ON (located in the cabinet on the starboard side at the aft end of the salon).
2. Turn the engine room ventilation blowers ON. It is recommended that they are run for a minimum of four minutes prior to actual engine start.
3. Place the transmission selector lever in the NEUTRAL ("N") position.
4. Position the throttle control slightly above the idle position.
5. Turn the DC ignition breaker switches ON (pilothouse level).
6. For a low temperature start (below 14°F/-10°C), use the preheater system. Hold the button in for 15 to 30 seconds (do not exceed 30 seconds).
7. Turn the ignition key clockwise to start the port engine first. **DO NOT** continuously operate the starter for more than 15 seconds at a time.
8. If the engine does not start, wait at least 30 seconds before making another attempt. If after two attempts the engine does not start, try to determine the cause before proceeding.
9. A "low oil pressure" buzzer will activate when the key is turned on. If this warning does not cease within a few seconds after start-up, turn the engine off and investigate before a restart is attempted.
10. When the port engine starts, release the key and allow it to return to the running position. Start the starboard engine in the same manner.

⚠ WARNING

Do not use ether or starting fluid as a starting aid as this may result in a fire or explosion.

11. Do not "race" the engines or allow either engine's RPM to exceed slow speed (750-1200 RPM) until they have warmed up.

Engine Idling Inspection

⚠ WARNING

Carbon monoxide is a poisonous gas that is colorless, odorless and heavier than air. It can accumulate in the lower regions of the boat in dangerous concentrations if proper ventilation is not provided. A person breathing these fumes could become seriously ill or even suffocate. Always run the bilge blower whenever running below cruising speed.

1. As the engines are warming up:
 - Check that the oil pressure reading is at least 40 PSI. IMMEDIATELY stop the engine if low oil pressure is indicated and determine the cause prior to attempting a restart.
 - Observe the exhaust outlets to verify cooling water discharge.
2. Allow the engines to warm up for 5-10 minutes. With the idle speed at approximately 1000 RPM, check the following:
 - Oil pressure 40 PSI or higher
 - Water temperature 135° - 190°F
 - Voltage meter 12-15.5 volts
 - Fuel gauge Sufficient fuel
 - Exhaust gas Should be colorless or light blue. Also, there should be water outflow with the exhaust; this indicates cooling water circulation.
3. Prior to closing the engine hatch, check for liquid and exhaust leaks, and remove tools, gloves, rags, etc. from on and around the engine.

⚠ WARNING

Always pull the throttle lever back to SLOW before moving the shift lever to FORWARD or REVERSE. Failure to do so can cause transmission damage and possible injury or death.

4. Turn the steering wheel full port and starboard and check for proper operation.

New Engine Break-In

All engines are test run prior to delivery. Nevertheless, it is extremely important to follow proper break-in procedures to insure many years of economical and trouble-free operation.

1. During the first 5 hours of operation, do not exceed an engine speed of 2500 RPM.
2. From 5 to 30 hours of operation, do not run at full throttle speed for more than 5 minutes.
3. During the first 30 hours, it is recommended that the engine is neither idled nor operated at a single RPM setting for extended periods of time.

Before You Leave

Before you leave the dock, perform the following steps in addition to the instructions listed under "Starting Procedures":

1. Check fluid levels in the generator.
2. Check the operation of the more essential equipment such as bilge pumps, running lights, wipers, water system, radios, navigation aids, etc.
3. Instruct passengers in the use and location of flotation devices and fire extinguishers.
4. Fill the fresh water tanks.
5. Obtain a reliable weather forecast and plan accordingly for everyone's comfort and safety.
6. Notify a responsible friend or relative of your cruise plans. Upon your return or a change in your cruise schedule, notify that person again in order to avoid unnecessary concern.

Maneuvering

When all of your predeparture checks have been completed, you will be ready to leave the dock.

Basic Maneuvering

Steering your yacht at either idling or cruising speeds will generally require minimal effort. Practicing maneuvers at slow speeds will help you to become familiar with all the special handling characteristics associated with your boat.

Remember that all boats steer by the stern (the feeling is much like steering your automobile in reverse). This means that the stern of your boat will swing in the direction opposite to your turn. For example, when you turn the helm wheel to port, the stern of the boat will swing to starboard as the boat goes into a port turn. This is especially important to keep in mind when docking and when operating in close quarters with other boats.

Your boat has twin propellers, so you can engage one engine in forward gear and the other in reverse gear to turn the boat completely around in its own length. Usually the rudders are left in the centered position. You can make such a turn in either direction. Port engine forward and starboard engine in reverse spins you clockwise. Starboard engine forward and port engine in reverse spins you counter-clockwise. You usually can increase the rate of spin by turning the rudders in the direction of the spin.

Always use extreme caution when approaching someone in the water. Approach them from the leeward side at idle speed only, allowing your stern to swing away from them as you get close. Place the shifter in NEUTRAL and shut off the boat's motor when you are still several feet from the person in the water. While they are swimming over to the boat, lower the swim ladder from the transom platform so they can board. Once everyone is aboard, return the swim ladder to its stowed position and check that everyone is safely seated before restarting the motor. If you are unfamiliar with picking up swimmers in the water, practice this maneuver with a retrievable floating object before attempting it under actual condition.

Boats have no brakes. Stopping is accomplished by backing down on the throttle. Once the boat has slowed and the motor is idling, place the shifter in REVERSE. Gradually increasing reverse power with the throttle will allow you to stop the boat in a very short distance. Note that a boat will not respond to steering in reverse nearly as well as it does when going forward, so do not expect to accomplish tight turning maneuvers when backing up.

Once you are away from the dock, devote some time to learning how to maneuver.

- Practice docking by using an imaginary dock.
- Practice stopping and reversing.
- When operating in close quarters or docking, all maneuvering should be done at idle speed. Proceed with caution in congested areas.
- Gradually increase your speed. Get used to the boat before attempting any full throttle operation.

Docking

Preparation:

Proper docking requires practice and preparation. Start by making sure you have adequate mooring gear, and that it is stowed correctly and is ready for use. Your dealer is the best source for information concerning the amount and type of equipment you should carry.

Approaching the Dock:

When approaching a mooring area, lower your speed within a reasonable distance to allow your wake to subside before it reaches other boats or docks. As you get close to your moorage, check for any wind or current action that may affect your maneuver; then make a conservative approach with these factors in mind. Try to use the elements to your advantage. Allow them to carry the boat to the dock. If there are high winds or strong currents, it is best to approach the moorage from the lee side. While approaching, check to see that all lines are attached to the cleats on the side facing the moorage. Also insure that fenders are lowered on that side. Be sure to check that the fenders are hung at the proper height.

As you approach your moorage, it is desirable to have one person at the bow and one at the stern of the boat, each with a boat hook and a mooring line attached to a cleat. Approach at idle RPM at an angle approximately 45 degrees to the dock. When the bow is within a few feet of the dock (starboard side), the stern can be brought alongside the moorage by reversing the port engine and leaving the rudders amidships. These steps are reversed for docking to port.

WARNING

Whenever docking all crewmembers and passengers should remain in the boat until maneuvering is complete. Do not attempt to dock with anyone standing on the transom platform. Also do not attempt to fend the boat away from objects being approached with with your body including hands and feet .

Mooring:

To attach lines to deck cleats, make a loop in one end of the line and pass it through the hole in the base of cleat; then pass the loop back over the entire cleat. The line can now be used to secure your boat. Lines may be kept this way while underway as long as they are coiled and cannot become fouled in deck gear or props. In heavy sea conditions, all lines should be removed from the decks.

WARNING

Whenever you are towing another boat, or having your boat towed, make sure the towline is fastened securely to the bow or transom towing eyes only. Never attach a towline to deck cleats or the anchor windlass, as serious injury may result if the cleats or windlass pull free from the deck. Also, to reduce the danger created by a potential failure of the towline, everyone should stay well clear of the towline attachment points on both the towing and the towed boats.

Leaving the Dock:

Take into account wind, tide, current and other forces that affect your maneuvering. Most maneuvering to and from a dock is best accomplished at idle speeds. Do not forget to release mooring lines, unhook shore power cords, and stow fenders.

Boat Performance

Boat speeds are affected by a great many factors. Some, such as temperature and altitude, you cannot change, but some factors you can:

1. Loading: Take only necessary equipment with you. Keep weight low in the boat and balanced.

2. Propellers: Keep them in good repair and at the correct pitch for your particular situation. The factory standard propellers may not be the best for your particular boat and load conditions. The engine should be able to come up to 3000 RPM on a normally loaded boat. If the engine RPM at full throttle is not 3000 ask your Bayliner Motoryacht Dealer about trying different propellers.
A slightly bent or nicked propeller will adversely affect the performance of your boat.
3. Keep your yacht's bottom clean of weeds, barnacles and other growth. When your boat starts "growing grass", it will slow down greatly.

Boat Running Attitude

1. If your boat runs with its bow too high at cruising speeds, move weight forward in the boat or adjust the trim tabs (see trim tab section below).
2. If your boat runs with its bow too low at cruising speeds (usually indicated by steering difficulty), you can raise the bow by moving weight aft or adjusting the trim tabs (see trim tab section below).

Trim Tabs

Trim tabs are used to control the longitudinal and lateral trim of your boat at cruising speeds. Two rocker switches, identified by the words BOW DOWN, are located at each helm station.

Your 4588 Motoryacht generally operates more efficiently if an extreme bow-high attitude is avoided. A more level attitude (only slightly bow-high) can be set by activating both rocker switches together.

Once the best bow cruising attitude is achieved, activate the port or starboard trim switches individually to correct for unequal lateral loading. Do not use trim tabs to compensate for excessive unequal weight distribution.

Trim tab adjustment should be performed by several short touches of the trim button, rather than one long one. Allow approximately five seconds for the hull to react between each switch activation.

The trim tab hydraulic fluid reservoir is located on the starboard side of the transom. The fluid level should be checked periodically (at least once per year) and refilled as necessary.

WARNING

Improper use of trim tabs will cause a loss of control. Do not use trim tabs in a following sea, as they may cause broaching or other unsafe handling characteristics. Do not allow people who are unfamiliar with trim tabs to operate them.

Instruments

While under way, instruments should be checked frequently for possible indications of trouble.

1. *Tachometer*—A tachometer is an electrical instrument that indicates engine revolutions per minute (RPM). The tachometer is useful for monitoring engine speed to avoid exceeding the maximum RPM rating.
2. *Temperature Gauge*—The temperature gauge indicates engine coolant temperature by monitoring a signal from a sending unit installed in the engine water jacket. When the gauge reads in the danger area, shut off the engine and diagnose the problem. A common cause of overheating is picking up a foreign object in the seawater intake. Clearing the intake or seawater strainer will usually rectify this problem.
3. *Oil Pressure Gauge*—The oil pressure gauge indicates engine lubricating oil pressure. Low pressure readings are generally caused by low oil quantity. In any case, immediately shut down the engine and diagnose the problem.
4. *Fuel Gauge*—The fuel gauge indicates the approximate fuel level. Since boats are exposed to rough water conditions and varying degrees of trim, it will not always be possible to fill the tank to 100% of

its dry-rated capacity. Therefore, fuel gauges may seem to provide inaccurate readings at times. It is always good to keep track of the amount of fuel you pump aboard, as well as your running time and estimated fuel usage as a double check against an inaccurate gauge.

5. *Compass*—Your yacht comes equipped with a compass for use in marine navigation. Many factors affect the operation of your compass, such as local magnetic variation and deviation (induced needle deflection caused by metal components, the operation of electrical equipment aboard your boat, and items containing ferrous metals i.e. binoculars that may be set near the compass). Each compass must be “swung” (compensated) to adjust for individual boat characteristics, and for the particular compass installation. It is vitally important, therefore, that you have your compass professionally swung before using it for marine navigation. Your Bayliner dealer can refer you to local shops that perform this work.

Dual Station Operation

Always start the engines at the station from which you will be operating the boat. Remind everyone near the unattended control station to **KEEP HANDS OFF**. When leaving one station to begin operating at the other, bring the boat to a complete stop. Never leave the helm while the boat is underway and assume that someone else has the boat under control. If you are operating your boat from the bridge and you encounter heavy sea conditions, bring the engines down to idle, point the boat into the sea and have bridge passengers move down to the cabin. If sea conditions become very heavy, you should also leave the bridge and operate your boat from the lower station. Children should be required to wear life jackets.

Structural Limitations

Cabin tops and flying bridges are designed to be lightweight for proper boat balance. The cabin top and flying bridge load limit for your yacht is 1000 pounds. The transom platform is designed to accept a maximum 400 pound load, and the bow anchor platform will accept a maximum 200 pound load.

Engine Shut-Down

1. Cool the engines down gradually, allowing them to idle in neutral for at least five minutes.

NOTICE

Gradual cool-down of turbocharged engines is absolutely necessary to avoid shortened turbocharger life.

⚠ CAUTION

It is important to follow steps 2, 3, 4, and 5 in sequence to avoid the possibility of electrical system damage.

2. To turn the engines off, push the STOP buttons.
3. After the engines stop rotating, turn the ignition keys counterclockwise to the OFF position.
4. Turn the DC ignition breaker switches to the OFF position.
5. Turn the battery switch OFF.
6. Close the seawater intake valves (seacocks).
7. Close the fuel supply valves.
8. Carefully inspect the engine and engine compartment for indications of oil, fuel, water, or exhaust leakage.

NOTICE

Steps 6, 7, and 8 need not be followed for short term shut-down (overnight). For longer term storage refer to the storage section of this manual.

COMPONENTS/SYSTEMS

The following are highlights of some of your yacht's onboard systems and components. Additional details are included in literature supplied with your yacht.

WARNING

To reduce the risk of electrical shock, only qualified personnel should install batteries and perform electrical system maintenance. You can minimize the danger of fire and explosion by not exposing the batteries to open flame or sparks. It is also important that no one smoke anywhere near the batteries. Because fuel fumes are heavier than air, they will collect in the bilge areas where they can be accidentally ignited. Running the bilge blowers for at least four minutes prior to engine starting, electrical system maintenance, or activation of electrical devices will decrease the danger of fire and explosion. Also, insure that all battery switches are in the OFF position before performing any work in the engine spaces.

Electrical System (12-Volt DC)

Electrical system diagrams are provided in the back of this manual for use in troubleshooting electrical problems.

CAUTION

The crossover switch should be turned on only in emergencies. Leaving this switch ON can drain all onboard batteries. Also, you should never disconnect battery cables or turn the main battery switches to the OFF position while the motor is running, as this can cause damage to your boat's electrical components, and possibly could shock you.

The rotary switches that control the batteries are located in the aft cabinet on the starboard side of the salon. Separate switches are provided for all three batteries. In addition, a crossover switch is provided to enable you to start the engines using the accessory battery in the event that engine battery power is low. The crossover switch also allows you to operate accessories off the engine battery. **The crossover switch is to be used only as a temporary remedy and should be turned off after use.**

Battery condition can be easily checked on the "Electrical System Monitor" located on the pilot-house instrument panel. Note that the condition of the accessory battery can be read on the voltmeter marked "ACCESSORY CIRCUIT" whenever the accessory battery switch is in the ON position. The starboard ignition switch *does not* have to be on to read the accessory battery condition. That means the starboard voltmeter will register the accessory battery state even when the engines are shut down and ignition switches are turned off.

The batteries supply you with electricity for lights, engine and generator starting, and power to run the accessories. **Periodically remove the battery caps and check the electrolyte level.** If the zinc plates are exposed, add distilled water until they are covered again. Corroded battery terminals can be cleaned with baking soda and water. Then coat them with a preservative or a light film of grease. Be sure all battery connections are tight.

The engine alternators will maintain proper charge levels in the engine and accessory batteries (some situations may require running engines at 1200 RPM to initiate charging). The port engine and starboard engine start and run off the start (engine) battery. This battery is charged by the port engine. The accessory battery is charged by the starboard engine. The isolation of the charging circuit on the starboard engine is accomplished by the use of a special alternator exciter circuit. This circuit is fused at the accessory battery switch. The exciter circuit is activated by an oil pressure switch installed on the starboard engine. When the starboard engine is started, the oil pressure comes up, the pressure switch closes, the exciter circuit is energized, and the alternator charges the accessory battery.

In addition to the engine alternators, the 4588 Motoryacht is equipped with a battery charger. The battery charger is located in the aft end of the engine compartment on the starboard side. The battery charger will charge all three batteries whenever the boat is plugged into 110-volt shore power or whenever the generator is operated. The circuit breaker for the battery charger (located on the main AC power panel) must be in the ON position for charging to occur.

Breaker switches are located on the instrument panel in the pilothouse. Some equipment, such as depth sounders and bilge pumps, may have secondary fuse protection located at the unit.

Electrical System (110-Volt AC)

AC electrical system diagrams are provided in the back of this manual for use in troubleshooting electrical problems.

The AC system is energized by either shore power or the onboard generator. Power source selection is made by a rotary switch on the AC control panel located on the starboard side of the pilothouse.

Three shore power receptacles are found outside the pilothouse on the starboard side. Shore power receptacles are rated at either 30- or 50-amps and appropriate power cords are furnished. Since not every shore installation has 30-amp service, we recommend that 15- and 20-amp adapters be purchased. However, whenever 15- or 20-amp adapters are used, there will be a corresponding drop in supplied power from the dockside system. **Note that you should never hook dockside power to your boat overseas unless you purchased the overseas option, which is rated for 220 volt/50 Hz., whereas standard domestic systems are rated for 110 volt/60 Hz. power.**

When connecting to shore power, turn off the main circuit breakers on the AC control panel. Always attach the cord to the boat first, then attach the cord to the shore outlet. This will prevent you from accidentally dropping a "hot" cord into the water. When preparing to leave, remove the cord at the dock outlet first, then disconnect it from the boat, close the outlet cover on the deck and secure the cord.

WARNING

Monitor the electrical control panel's polarity indicators when connecting shore power to your boat. A green light illuminating after the power cord is plugged into the boat's external power receptacle indicates acceptable electrical power. Therefore, you may energize the main breaker switches. However, a red light indicates *reversed polarity*, which could cause electrical system damage and possible electrical shock injuries. In this case, DO NOT energize the main breaker switches. Instead, immediately disconnect the shore power cord (always from the dockside outlet first) and notify marina management.

Should you be unable to hook shore power up to all three receptacles, paralleling switches on your AC panel allow you to operate accessories using less than three power cords (however, you must be more selective as to which and how many accessories you operate in order to avoid an overload).

Whether using shore power or the generator, the simultaneous operation of several 110-volt accessories can result in an overloaded circuit. It might be necessary to turn off one accessory while operating another. Amperage draw can be monitored for each of the three lines by checking the ammeters on the AC control panel.

Diesel Generator

The literature package supplied with your boat has a very complete operator's manual for your generator. We urge you to read that manual prior to initially operating your generator. The following are some highlights concerning this unit.

1. Follow instructions in the operator's manual for prestart checks and break-in procedures.
2. Starting switches and gauges are located on the AC electrical panel on the starboard side of the pilothouse. The generator battery switch is located in the cabinet on the starboard side wall, aft end of the salon.
3. Always operate the bilge blower for a minimum of four minutes before starting the generator. Leave the blower running while the generator is operating unless running the boat at cruising speed.
4. Never operate the starter for more than 30 seconds. If the generator does not start, wait at least 30 seconds before another starting attempt is made.
5. Fuel to run the generator is supplied from either the port or starboard fuel tanks. **You should set the fuel selector valves so that return fuel is routed back to the same tank from which it was drawn.** Otherwise, in cases where generator fuel is drawn from a nearly empty tank and returned to a full tank, it is possible to accidentally spill fuel overboard through the tank venting system.
6. In addition to servicing the filters attached to the generator, the filter/separator located near the fuel line valves should be serviced as described in the instructions included with your literature package.
7. The coolant mixture installed at the factory consists of equal parts of water and antifreeze.
8. The seawater intake valve should always be open during generator operation, and the seawater strainer should be frequently checked for debris.
9. Approximate normal gauge readings during generator operation are: temperature = 165° to 195° F; oil pressure = 30-55 PSI.

Hot Water Heaters

Dual hot water heaters are located in the engine compartment on the port side of the removable step in the salon.

Heaters must be kept full of water to avoid damage to the 110-volt heating elements, and they should be drained when the possibility of freezing exists (power turned OFF).

There is a heat exchanger system connected to the port engine; hoses related to this system should be checked frequently for condition and leakage.

WARNING

Water heated by the heat exchanger system can reach temperatures high enough to scald the skin. Use care when using the hot water after running the port engine for any period of time.

Air Conditioning/Heating

Both heating and cooling are controlled from the same panel. Refer to the Environmental Control Unit booklet supplied in your information packet for detailed instructions concerning proper operation of the heating and air conditioning systems.

Anchor Windlass

The literature package includes instructions for the anchor windlass. In high winds or heavy seas, propel the boat towards the anchor to assist in the retrieval of the chain. Do not continue to operate the winch if it has stalled or overloaded.

Davit

See the literature package for complete operating instructions for the davit (winch). It is important to inspect the cable for wear and to replace it when frayed. The cable should be kept tight and even on the spool, and under tension when operating the winch.

It is recommended that you disconnect the cables from the bulkhead-mounted quick-disconnect fittings when the davit is not in use, due to the possibility of electrical shock. After removing the cables, the load should be secured.

⚠ WARNING

Do not exceed the load limit of the davit system, see the literature package for specifications. Remember, water is heavy, lifting the dinghy to drain it's bilge may exceed the davit's limit. Also use extreme care when using the davit in rough weather or sea conditions as the load may be set swinging.

Fuel System

See the DIESEL FUEL SYSTEM drawings for a basic description of this system.

Using the supply valves, fuel can be directed from either tank to the engines and generator as desired.

Filter/separators should be inspected and maintained as detailed in your engine manual, generator manual, and in the filter literature supplied with your boat.

Make sure that your fuel suppliers are reputable and can be relied upon to furnish clean, high quality fuel. Once you have found such suppliers, keep your tank as full as possible with their fuel. Then, if you are forced to add to the tank with a potentially poor quality supply, the portion of poor quality fuel will be minimized.

Diesel fuel of ASTM grade 2-D is recommended. The minimum cetane value is 40 (45 for cold temperature operation), and the maximum sulfur content is 0.5%. If sulfur content exceeds 0.5%, oil changes should be performed twice as frequently as indicated in the engine manual.

Air should not be allowed to enter the fuel supply system. Should air be introduced into your fuel lines, refer to your engine manual for detailed instructions on "bleeding".

Consult your dealer or local marina concerning fuel additives that help to prevent fungus growth in your fuel tanks.

Shaft-Transmission Alignment

Alignment between your engine transmission output shaft and the propeller shaft is very critical. Although this alignment has been performed at the factory, it should be checked again after the boat has been in the water for 48 hours. Alignment inspection should be performed as part of the routine maintenance program (after the initial 30 hours of operation, then every 60 hours) and whenever unusual noise or vibration is noticed. To insure proper alignment when the boat has been launched after a haul-out or dry storage, wait for 48 hours before making final adjustments.

Proper alignment is usually achieved by moving the engine. We recommend that alignment be performed by an experienced marine mechanic.

Shaft Log Stuffing Box Packing

The propeller shaft emerges from the bottom of the boat through an opening called the shaft log. The shaft stuffing box is connected to the shaft log by a short length of special flexible hose. Packing rings are compressed around the shaft by the packing nut. The stuffing box prevents excessive amounts of water from leaking around the shaft and into the boat.

Normal wear can cause stuffing box leakage to increase. It usually can be stopped by loosening the locknut, tightening the packing nut slightly, and then resetting the locknut. Do not overtighten the locknut.

Bear in mind that a slight leak (up to 10 drops per minute while running) helps to lubricate the packing and is therefore **necessary**.

When stuffing box leakage becomes excessive, even after following the above steps, packing replacement can be performed as follows:

1. Remove the boat from the water.
2. Loosen the locknut and back the packing nut off the sleeve. Remove the old packing.
3. Wrap new packings around the shaft (4 rings, 3/16"), then cut the rings with a razor blade at an angle approximately 30 degrees to the long axis of the shaft. Stagger the ends of each ring around the shaft and insure that the rings bottom in the nut.
4. Tighten the packing nut by hand until resistance is felt. Then tighten the locknut securely.
5. When initially launched, the packing must be allowed to leak at a rate of 5 to 30 drops per minute, as it will expand and seal from water contact and friction heat from the turning shaft. Failure to allow this leakoff will result in packing burnout after a short period of time.

Rudder Stuffing Gland

As in the case of the shaft log stuffing box, the rudder stuffing gland is part of the assembly where the rudders emerge from the bottom of the boat.

It is very similar to the propeller shaft stuffing box and will require the same maintenance. Since it does not receive the same wear as the propeller shaft, repacking is seldom required. This shaft stuffing gland should not leak water.

Stove

All 4588 Motoryachts are equipped with an electric range/oven. Before attempting to operate the range/oven, make sure the breaker switch on the AC Master Panel is ON. Operating instructions can be found in the boat's literature package.

Steering

Your steering system is manual hydraulic, not power steering. At no time should you expect this system to turn as easily as a car's power steering.

You may notice a rhythmic pulsing when turning the wheel; this is a characteristic of the pump and is not a malfunction. Also, when coming off a hardover position, a resistance may be felt, followed by a distinct sound. This is a normal situation resulting from the release of the check valve.

The fluid reservoir for the hydraulic steering system is located in the aft end of the engine compartment. Following instructions in your literature package and on the reservoir, check the fluid level and pressure regularly.

Spotlight

The spotlight can be controlled from either helm station, provided the dual switch in the pilothouse is activated for the station at which you desire control.

Refrigerator

The refrigerator used in your Pilothouse Motoryacht operates on 110-volt AC and 12-volt DC power. When the 110-volt system is not operating, the refrigerator operates on 12 volts. When an AC source is supplied by a generator or dockside power, the refrigerator automatically switches over to the 110-volt power supply.

The refrigerator is the heaviest continuous draw on the 12-volt DC system. If no other 12-volt accessories are used, the refrigerator can draw a 100 amp battery dead in less than 24 hours. For this reason

it is recommended that when operating on 12 volts, the cold setting on the refrigerator should not be set higher than position TWO. It is also advisable to turn the refrigerator off at night. If you are going to be out more than one day and cannot connect to dockside power, you should plan to run your generator or engines to maintain a charged battery.

Seawater Strainers

Seawater strainers should be periodically checked for debris. There is a strainer for each engine, one for the generator, and one for the air conditioning system in the engine compartment. A strainer for the seawater washdown pump is located behind the hanging locker back panel in the aft stateroom.

Exhaust System

The yacht exhaust system is designed to keep water out of the engines in most sea conditions. However, care should be taken not to anchor stern to sea, and the engines should not be shut off if the seas are too high. Always use good seamanship and consider the sea condition before anchoring or shutting off the engines.

Check all of the exhaust system clamps after the first 20 hours. Continue to check the clamps periodically after that.

Potable Water System

See the POTABLE WATER SYSTEM drawings for a basic description of this system.

The water filter should be inspected frequently and cleaned as required.

When connected to a dockside water supply, the DC power switch for the water pump should be left in the OFF position.

Sinks and showers ("gray water") drain overboard. Sinks above the waterline have gravity drains while the aft head sink and both showers are pump-drained. Pumps are located behind the sliding door on the starboard side at the forward end of the passageway. Drain pumps should be turned OFF after the shower or aft head sink are drained.

Water tanks are equipped with water level indicators. Because indicators are not 100% accurate, water tanks should be topped off at every opportunity to avoid the possibility of running short of potable water.

When your boat is to be left unattended for an extended period of time, pump the water tanks dry to prevent stored water from becoming stagnant and distasteful.

Marine Head System

Refer to the drawing and specific literature relative to your yacht's head system.

The system is designed so that waste from either head may be flushed into the holding tank or, for those traveling where regulations permit, overboard. Routing is determined by the setting of "Y" valves in the compartment on the starboard side of the passageway, next to the stairs.

The holding tank can be emptied by dockside pump-out or, where permitted, by actuating the macerator pump (with the discharge seacock open) from the pilothouse DC panel.

The holding tank on your Motoryacht has a level indicator. Even so, it is advisable to empty the tank at every opportunity to eliminate the possibility of problems which might be caused by any indicator error.

Check with local authorities for regulations covering the legal use of marine head systems in your area.

Trash Compactor

Make sure that the breaker switch located on the AC Master Panel is ON before attempting to use the trash compactor. Detailed instructions can be found in the literature package.

Bilge Pumps

Your boat is equipped with two automatic bilge pumps, one located under the storage well between the diesel engines, and the other beneath the removable floor of the aft stateroom hanging locker. The electric bilge pumps supplied with Bayliners are impeller-type pumps. They are controlled by a switch on the dash panel, which should be activated whenever water begins to accumulate in the bilge. An automatic bilge pump switch ("autofloat switch") is mounted next to each pump. This is a float-type switch that will activate the bilge pump automatically whenever bilge water accumulates above a pre-set level. It is wired directly to the battery so it will normally function even when the boat is completely shut down and unattended, such as when the boat is moored at a marina.

Operation of bilge pumps should be checked frequently. To check bilge pumps, activate the dash-mounted switch and verify that any water in the bilge is pumped overboard. If bilge water is present and the pump motor is running but not pumping, check to see if the pump is clogged with debris. Squeeze the two holding tabs on the side of the pump housing inward and pop the pump's upper housing off. If the pump's strainer well is clear but the pump still does not move water, check the discharge hose for kinks or a collapsed area.

The autofloat switch should also be checked frequently for proper operation. Squeeze the two holding tabs on the side of the switch housing inward and pop the upper housing off. Remove any debris you find in the strainer well. Then raise the float to verify it has full up and down movement. As you raise the float to its full upward position, the bilge pump should turn on and empty all bilge water overboard. If raising the float does not switch the pump on, check if there is an in-line fuse in the wire between the switch and the battery. If there is, make sure it has not blown. If the fuse is good, but the switch still does not work, it usually indicates a bad switch, or possibly a low battery. In either case, call your dealership for further assistance.

NOTICE

The Federal Water Pollution Control Act prohibits the discharge of oil or oil waste into or upon the navigable waters and contiguous zone of the United States if such discharge causes a film or sheen upon, or discoloration of, the surface of the water, or causes a sludge or emulsion beneath the surface of the water. Violators are subject to a penalty of \$5000.

Washdown System

The outlet for the freshwater washdown system (potable water) is located on the starboard side of the aft cockpit. The outlet for the raw water washdown system (seawater) is located in the portside aft cockpit. The seacock, strainer and pump for the raw water washdown system are located behind the hanging locker back panel in the aft stateroom. To prevent burning out the pump, make sure the seacock is open before turning the system on.

Washer/Dryer

Access to the Washer/Dryer is on the port side of the hallway, forward of the aft stateroom. Before attempting to operate the Washer/Dryer, make sure that the breaker switch, located on the AC Master Panel, is ON. Further operating instructions are included in the literature package.

Radar

Your Motoryacht is equipped with a marine radar system that will give you a complete and accurate 360° radar picture of other vessels, buoys, and landfall surrounding your vessel. To turn this system on, the RADAR switch on the DC breaker panel must be activated. It is recommended that you become familiar with the operating procedures described in the literature supplied with your vessel before operating this system.

Autopilot

The autopilot will aid you in maintaining the chosen heading of your Motoryacht automatically. Before activating the AUTOPILOT switch on the DC breaker panel, refer to the literature supplied with your vessel. It will explain the safe operation methods for this system.

Stereo

The stereo that comes standard with your yacht has a separate brochure that explains its operating features. Note that AM radio reception will be impaired anytime the engine is running, and therefore it is suggested that you turn the AM radio off while underway.

Depth Sounder

Your yacht comes equipped with an electronic depth sounder. It will provide you with measurements of water depth beneath the boat. The depth sounder comes with its own owner's manual. We suggest that you read it carefully before turning on the unit.

WARNING

The depth sounder should not be used as a navigation aid to prevent collision, grounding, boat damage or personal injury. When the boat is moving, submerged objects will not be seen until they are already under the boat, or bottom depths may change too quickly to allow time for the boat operator to react. Always operate the boat at very slow speeds if you suspect shallow water or submerged objects. The 4588 Motor Yacht is not designed to be beached or run aground. Beaching or running aground may cause damage to the hull and/or running gear.

GENERAL MAINTENANCE AND REPAIRS

In addition to instructions found elsewhere in this manual and in the literature specific to certain components, the following information is provided for general maintenance and repair.

Because conditions vary widely in different areas, and since frequency and type of use can differ greatly between owners, intervals for maintenance are not listed here. Common sense should determine the frequency of maintenance.

Bilges/Engine Compartment

1. Pump the bilges dry and remove all loose dirt. Be sure all limber holes are open. If there is oil in the bilge and the source is not known, look for leaks in engine oil lines, coolers, transmission or engine gaskets. Oil stains can be removed by using a bilge cleaner available from your dealer or marina. **DO NOT** use flammable solvents.
2. Check all wiring to be sure it is properly supported, that its insulation is intact, and that there are no loose or corroded terminals. If there are corroded terminals, they should be replaced or thoroughly cleaned with sandpaper. Tighten all terminals securely and spray them with a light marine preservative oil.
3. Inspect the entire fuel system (including fill lines, vents, and supply and return lines) for any evidence of leakage. Any stains around joints could indicate a leak. Try a wrench on all fittings to be sure they are not loosening, but do not overtighten them. Clean fuel filters and vent screens. Operate all valves to be sure they are in good condition. This is best performed by a qualified mechanic.
4. Inspect the entire bottom for evidence of seepage, damage or deterioration, paying particular attention to hull fittings, hoses, and clamps. Straighten kinked hoses and replace any that do not feel pliable. Tighten loose hose clamps and replace those that are corroded. Tighten any loose nuts,

bolts, or screws. Operate seacocks to be sure they are in good condition. Seacocks need lubrication to ensure a long working life.

5. Refer to your engine operating manual for engine maintenance details. Wipe off engines to remove accumulated dust and grease. If a solvent is used, make sure it is nonflammable. Go over the entire engine and tighten loose nuts, bolts, and screws, including the mounts (however, do not turn the mount adjusting screws). Inspect the wiring on the engine and clean and tighten the terminals. Inspect the belts and tighten them if needed. Replace any belt that is cracked or frayed. Clean and lubricate the battery terminals; fill the cells with distilled water as needed.

Cabin and Topside Areas

1. Test all electrical equipment and appliances to make sure they operate properly. Inspect all wiring for proper support, sound insulation and tight terminals. Pay particular attention to portable appliance cords and plugs.
2. Inspect and operate heads, basins, showers and sinks. Also, inspect the freshwater system plumbing, including the tank. Check and operate the water pumps, including the shower pump and the sink drain pumps. Check all water lines and connections for leaks, and make sure all connections are tight.
3. Check bow rails, ladders, and grab rails for loose screws, breaks, sharp edges, etc. that might be hazardous in rough weather. Inventory and inspect life jackets for tears and deterioration. Check your first aid kit to make sure it is complete. Check the signaling equipment. Inspect anchor, mooring and towing lines and repair or replace as required. **DO NOT** stow wet lines as they may mildew and rot.
4. Salt and brackish water are capable of etching and damaging window glass. Keeping windows clean is the best preventive measure you can take. When window cleaning, flush with plenty of fresh water.

Exercise caution when cleaning windows and doors made of plexiglass because it tends to scratch easily.

First, use generous amounts of water to wash off as much dust as possible. Use your bare hands with plenty of water to dislodge any caked dirt. Then use a soft, grit-free cloth or clean, soft sponge with a cleaner made specifically for plexiglass. Never use a glass cleaning solution or a duster, as these will scratch the surface. **DO NOT** use solvents such as acetone, kerosene, benzene, carbon tetrachloride, fire extinguisher fluid, dry cleaning fluid, or lacquer thinner since they will attack the surface. When you are finished, rinse with fresh water and dry with a clean, damp chamois using a blotting action.

5. To keep teak looking fresh, it should be treated with teak oil at least twice a year (more often if exposure is severe). If the teak is in particularly bad condition, ask your Bayliner dealer for a good teak refurbishing kit.
6. Stainless steel railings and fittings should be cleaned with soap and water or household glass cleaner. Because irreversible pitting will develop under rust that remains on stainless steel for any period of time, it is best to remove rust spots immediately with brass, silver or chrome cleaner. Then coat the railing or fitting with a good automobile or boat wax. Never clean with mineral acids or bleaches. Also, do not allow stainless steel to come into continuous contact with iron, steel or other metals which could cause contamination leading to rust or corrosion.
7. A variety of high quality fabrics have been used in the construction of your boat. Proper care and cleaning of all fabrics on a regular basis will contribute to their long life. The most important thing to remember is that stains **must** be cleaned up immediately if the original beauty and strength of the fabric are to be maintained over a long period of time. Independent laboratory testing has shown that some sunscreen lotions and oils can permanently stain most types of vinyls and fabrics, so exercise care when using these products.

Prior to cleaning any fabric, we suggest that you **test your cleaning solution and method on a hidden or inconspicuous area**. That way, if that particular cleaning method causes damage, it will be confined to a small, less noticeable area.

Use a sponge or very soft scrub brush and a mild soap and warm water solution to clean exterior

fabrics. Rinse after scrubbing with plenty of cold, clean water and allow the fabric to air dry in a well ventilated place, preferably away from direct sunlight.

Convertible tops and vinyl upholstery can be cleaned using a mild soap and warm water solution also. Rinse after scrubbing with plenty of cold, clean water and air dry in a well ventilated place, again preferably away from direct sunlight.

Vinyl cleaners and conditioners are **NOT** recommended for use on Bayliner upholstery, as they tend to remove plasticizers that extend the life of the fabric. To prevent rainwater seepage at the seams, a coating of *Scotch Gard*® can be applied.

Mildew can occur if your boat does not have adequate ventilation. Heat alone will not prevent mildew; you must also provide for fresh air circulation. If mildew does occur, it often can be removed using a solution of warm water and laundry bleach (one cup of bleach to one gallon of warm water). Brush the solution into the affected area, let it sit for 10 to 15 minutes, and rinse with plenty of cold, clean water. Air dry in a well ventilated place, once again preferably away from direct sunlight.

If at all possible, the vinyl top parts of your boat should be stored indoors in a fairly warm, dry place. This will greatly extend the life of the material.

Dry cleaning should be considered for interior fabrics other than vinyl.

8. When marine instruments are exposed to a saltwater environment, salt crystals may form on the bezel and the plastic covers. These salt crystals should be removed with a soft, damp cloth; never use abrasives or rough, dirty cloths to wipe plastic parts. Mild household detergents or plastic cleaners can be used to keep the instruments bright and clean.

Hull

1. The finish on a fiberglass boat is similar to that of an automobile and will respond to the same system of care and cleaning.

Use a sponge and a mild soap and warm water solution to clean exterior surfaces of your boat. Rinse the boat well with plenty of clean water. Use a quality boat wax to protect the finish. Note that there are a variety of polishes and cleaners for fiberglass on the market. We suggest that you experiment with different brands to determine which work best for you.

2. Almost unavoidable during the life of your boat is damage to the gelcoat or colored surface. This is not as serious as you might think. Repair is not costly and can be done by the novice.

Scratches: If the scratch does not penetrate the gelcoat surface, it can be repaired with automotive rubbing compound. Dampen a soft rag and apply the compound with a continuous circular motion. The scratch may not disappear completely; however, its noticeability will decrease.

Gouges and Chips: To repair, obtain "patch paste" from your Bayliner yacht dealer and follow this recommended procedure:

- Clean the area to be repaired of wax and oil. Acetone is a good solvent.
- Mix a small portion of patch paste and catalyst according to the manufacturer's instructions.
- Apply the paste to the gouge with a putty knife or flat-edged stick; try to match the paste to the surface contour of the area being repaired. It is better to have an excess of paste, rather than not enough.
- Allow the paste to harden thoroughly. In most climates, one to two hours should be sufficient.
- Shape the patch as desired, using fine wet sandpaper.
- Finish by using automotive rubbing compound in the same manner as you did for small scratches.

WARNING

Teak oil, acetone and catalyst are hazardous materials and should be used only in well ventilated areas. Follow the manufacturer's instructions. Also, never store rags that have been wetted with acetone, teak oil, fuel or any other solvent aboard your boat. Immediately remove them from the boat and discard them properly to prevent spontaneous combustion and fire.

3. The bottom paint on your boat is designed to dissolve slowly to prevent marine growth. Therefore, it is unusual to find a boat bottom that does not need repainting after a season's use.

Periodically haul the boat out of the water and scrub the bottom with a bristle brush and a solution of soap and water. It is not always necessary to repaint the bottom each time it is scrubbed, but no bare spots should be permitted.

The recommended procedure for repainting the bottom is as follows:

- Prepare the bottom by sanding, cleaning and fairing as required.
- It is imperative that the new paint be applied over a perfectly dry surface. Fiberglass hulls should never be hauled, painted and relaunched on the same day, since this does not allow sufficient time for the moisture which has been absorbed into the old paint to completely dry out. Generally, 24 - 36 hours of drying time is required.

N O T I C E

Bayliner recommends the application of an epoxy barrier coating, such as International Paint Company's Interlux "Interprotect 2000 System", to help seal the hull bottom and reduce the possibility of gelcoat blistering on any boat that is permanently moored. The barrier coating should be covered with several coats of antifouling paint. Note that many states regulate the chemical content of bottom paints in order to meet environmental standards. Check with your local Bayliner yacht dealer about recommended bottom paints, and about laws that are in effect in your area.

4. Whenever your boat is out of the water you should check all metal parts for stray current corrosion. Stray current corrosion, or electrolysis, can be prevented several ways. The following are the most common causes and the simplest cures:
 - Wiring may leak a certain amount of electricity. Keep a clean, dry bilge.
 - A poorly grounded zinc anode: Check the ground wire and clean the contact surfaces.
 - The zinc anode may be deteriorated beyond effectiveness; replace it when it has deteriorated 50% or more.
 - If your boat is permanently moored, we recommend that you contact someone in your area specializing in corrosion control and have them check your boat in its moorage to see that it is properly protected.

Also, while your boat is out of the water, propellers, rudders, and shafts should be inspected for damage.

5. Every attempt has been made to equip your yacht with propellers that will optimize performance. Changes in altitude and load can affect performance; therefore, your boating needs may dictate a propeller change. Your Bayliner yacht dealer can help you in the selection of propellers better suited to your needs.
6. Your boat is equipped with twin rudders; occasionally check to see that they are mounted parallel to each other. Measure the distance between the leading edges of both rudders; then measure the distance between the trailing edges. The difference should be less than 1/4". Adjustment is performed at the transom, inside the engine compartment.
7. Flapper valves on cockpit scuppers should be checked often to see that they are pliable, and are providing the proper sealing action.

STORAGE

The following suggestions are offered for storage at the end of your boating season:

1. If your boat is to be stored out of the water, it is extremely important that its hull is properly supported to avoid permanent hull distortion. If your boat is stored inside, it should be in a well-ventilated building. (Refer to the "Sling Locations" drawing which depicts the proper placement for the slings used to lift your yacht. In addition to sling placement, it is important to use the proper spreader beams that place the slings vertical at the lift points).
2. A temporary winter cover is recommended if covered storage isn't available. A proper winter cover should keep the weather off the boat, but still provide adequate ventilation. Wrapping a boat in a tight plastic cover can do more damage than good. Dampness and lack of air circulation provide ideal conditions for the fungi that cause mildew and dry rot.
3. Fill the battery cells with distilled water to the proper level. A fully charged battery will survive storage better than one that is not.
4. Refer to your engine, generator, and accessory owner's manuals for specific storage instructions that apply to that particular component.
5. Drain the freshwater tanks and lines by opening all faucets and operating the water pump (be sure that the hot water tank power switch is turned OFF). Operate the pump until all tanks and lines are empty and no water flows from any of the faucets. Then drain the pump to prevent damage that can result from freezing. Remove the caps from both hot and cold lines to allow any remaining water to drain into the bilge and then overboard through the bilge pumps (caps are located in the engine compartment under the passageway stairs).
6. Flush each head several times. If the boat is to be stored in salt-water, close the intake seacock, add fresh water to the bowl and allow it to stand for a day or more to dissolve accumulated salt. Then, with the seacock closed, flush the head until it is pumped dry. Pump out the holding tank.
7. Where freezing temperatures are likely you may want to use an RV antifreeze in the water systems following the manufacturer's instructions.
8. Fuel tanks should be filled so there is little air space, thereby minimizing condensation.
9. Refer to your engine owner's manual for storage procedures related to the engine seawater cooling system. (Generator cooling system storage provisions are similar to those used for the main engines).
10. Thoroughly clean your boat. If possible, remove cushions, mattresses, blankets, towels, and other items that can hold moisture and cause mildew. Such items left on board should be positioned for maximum air circulation. It helps to stand mattresses and cushions on edge. Prop open doors, hatches, cabinets and ski lockers to allow fresh air to circulate.
11. Defrost and dry out the refrigerator and freezer; leave the doors propped open. Leave all drawers and locker doors open.
12. Clean all deck hardware; then coat the hardware with rust inhibitor.
13. Lubricate the steering mechanism and throttle control linkage.
14. Close all seacocks.
15. Provide as much heat and ventilation for interior spaces as is safe and practical.

We hope these preventive measures will help make getting ready again in the spring easier. Should you have any questions, your Bayliner yacht dealer is ready to provide assistance.

NAUTICAL TERMS

ABEAM:	On either side of the boat.
AFT:	To the rear, or near the stern.
BEAM:	The width of the hull.
BILGE:	The lowest portion inside a boat (in a fiberglass boat, generally the underdeck and lower portion of the engine compartment).
BOW:	The forward portion of the boat.
CHINE:	The intersection of the side and bottom of a V-bottom boat.
DRAFT:	Vertical distance from the waterline of the boat to the lowest point of the boat.
FATHOM:	A measurement of six feet, generally used to measure water depth.
FREEBOARD:	Vertical distance from the deck to the waterline.
GUNWALE:	The upper edge of the deck.
HATCH:	A covered opening in the deck.
HEAD:	Toilet or toilet room.
HELM:	Steering station.
KEEL:	The lowest external portion of the hull.
KNOT:	Nautical mile per hour; one nautical mile is 6,076 ft.; a land mile is 5,280 ft.
LEE:	Opposite side from which the wind blows.
PORT:	To the left side of the boat facing the bow.
PORTLIGHT:	A hinged window in the boat's cabin or hull.
SCUPPER:	An opening in a deck or cockpit permitting water to drain overboard.
STANCHION:	A fixed, upright post used for support (of rails or lifelines).
STARBOARD:	To the right side of the boat facing the bow.
STERN:	The rear of the boat.
TRANSOM:	The vertical part of the stern.
WINDWARD:	The direction from which the wind is blowing.

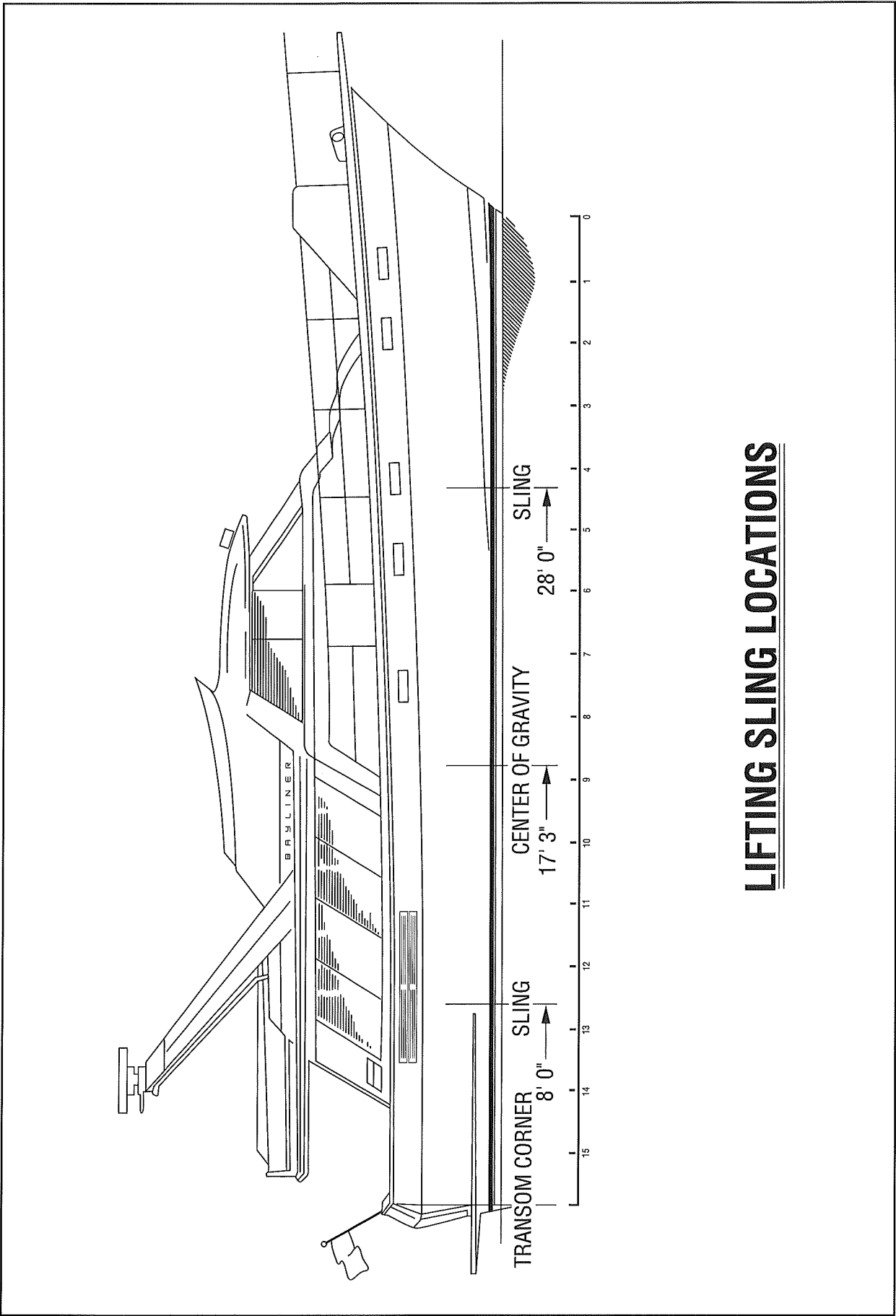

LIFTING SLING LOCATIONS

FUEL SYSTEM DIAGRAM

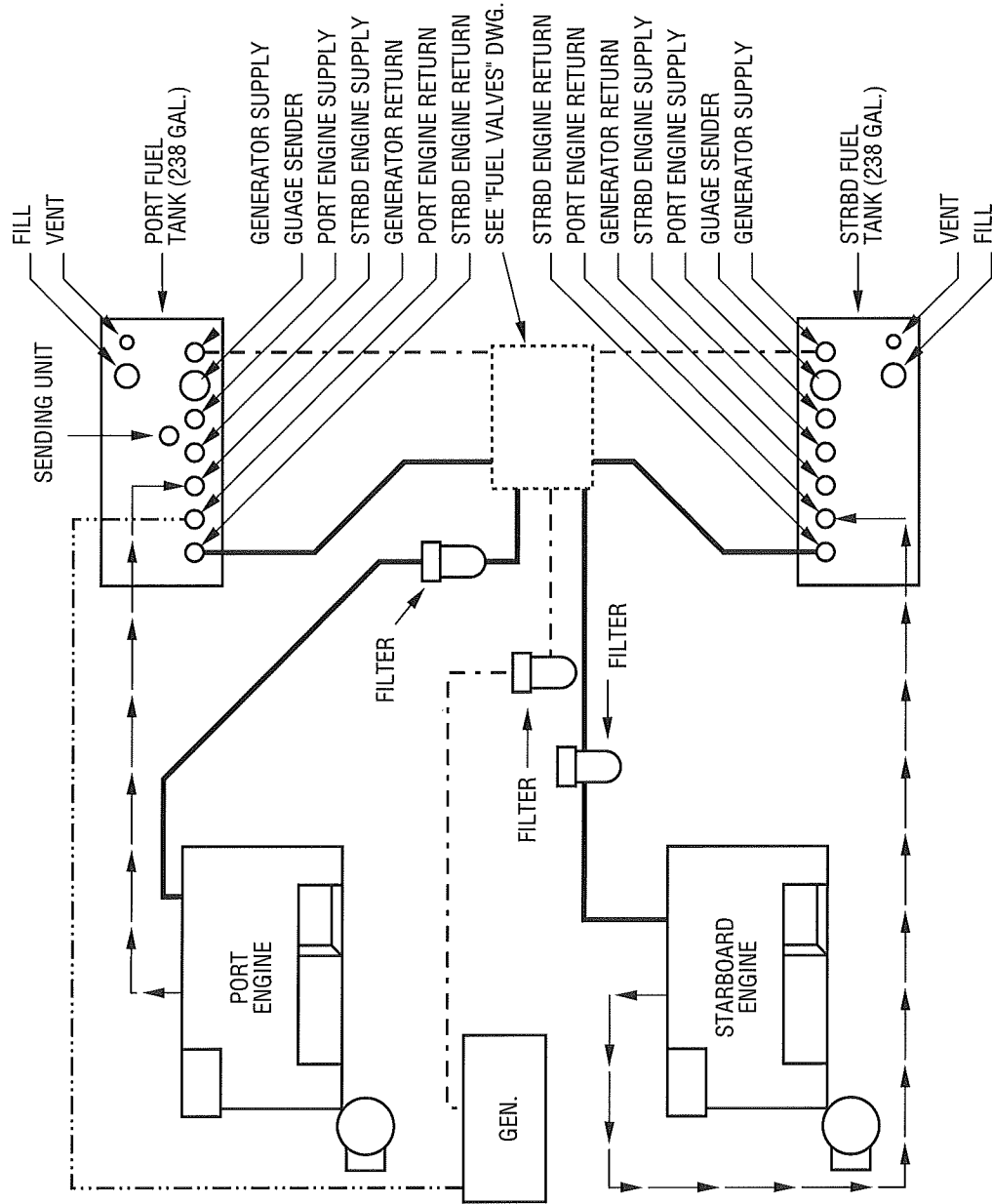

FUEL VALVE DIAGRAM

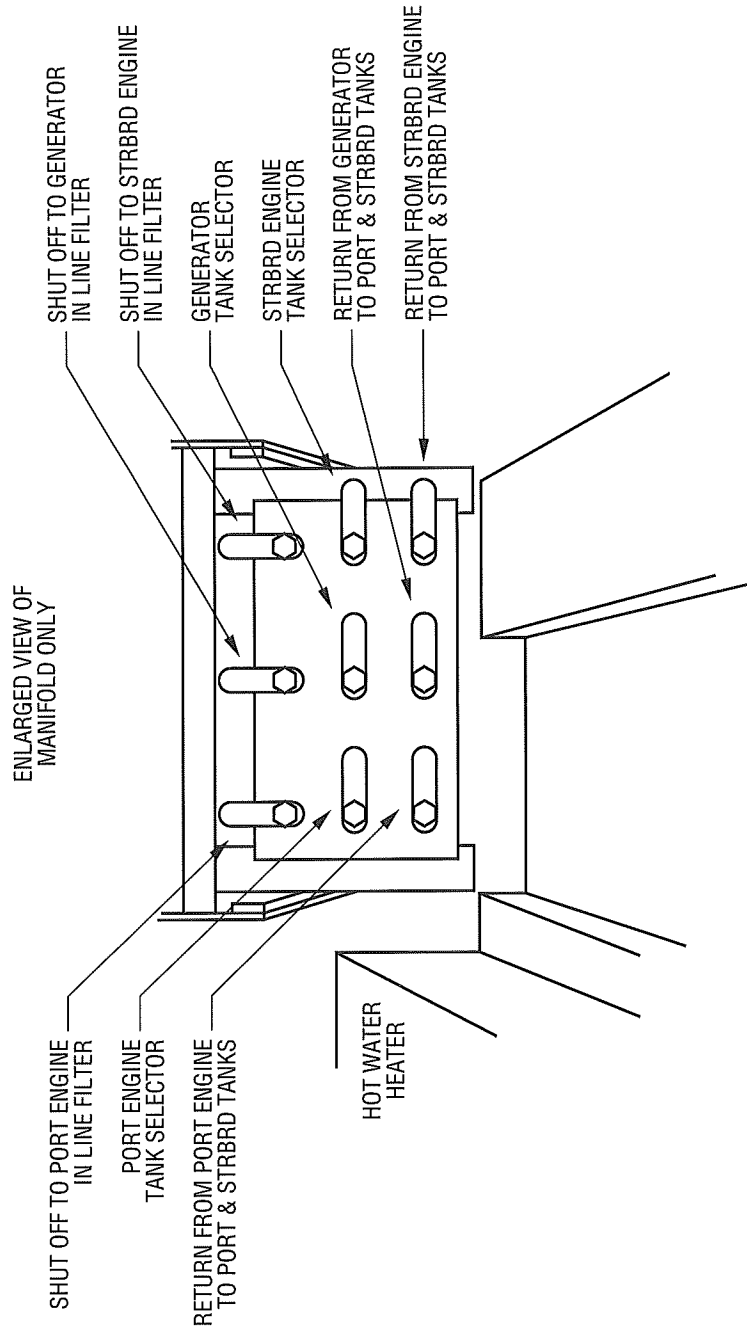

VIEW LOOKING AT
AFT SIDE OF
COMPANION WAY STAIRS

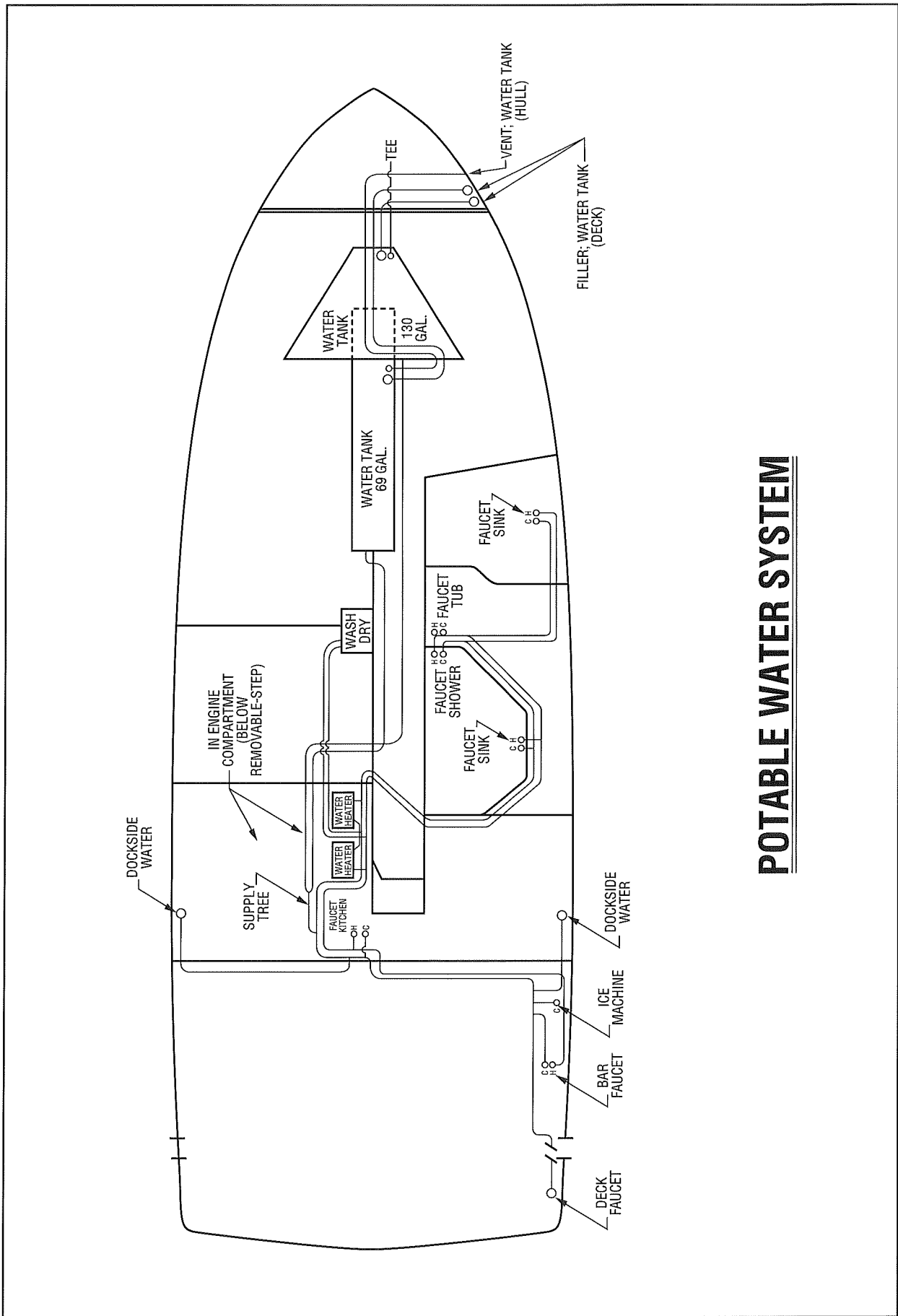

POTABLE WATER SYSTEM

MARINE HEAD SYSTEM

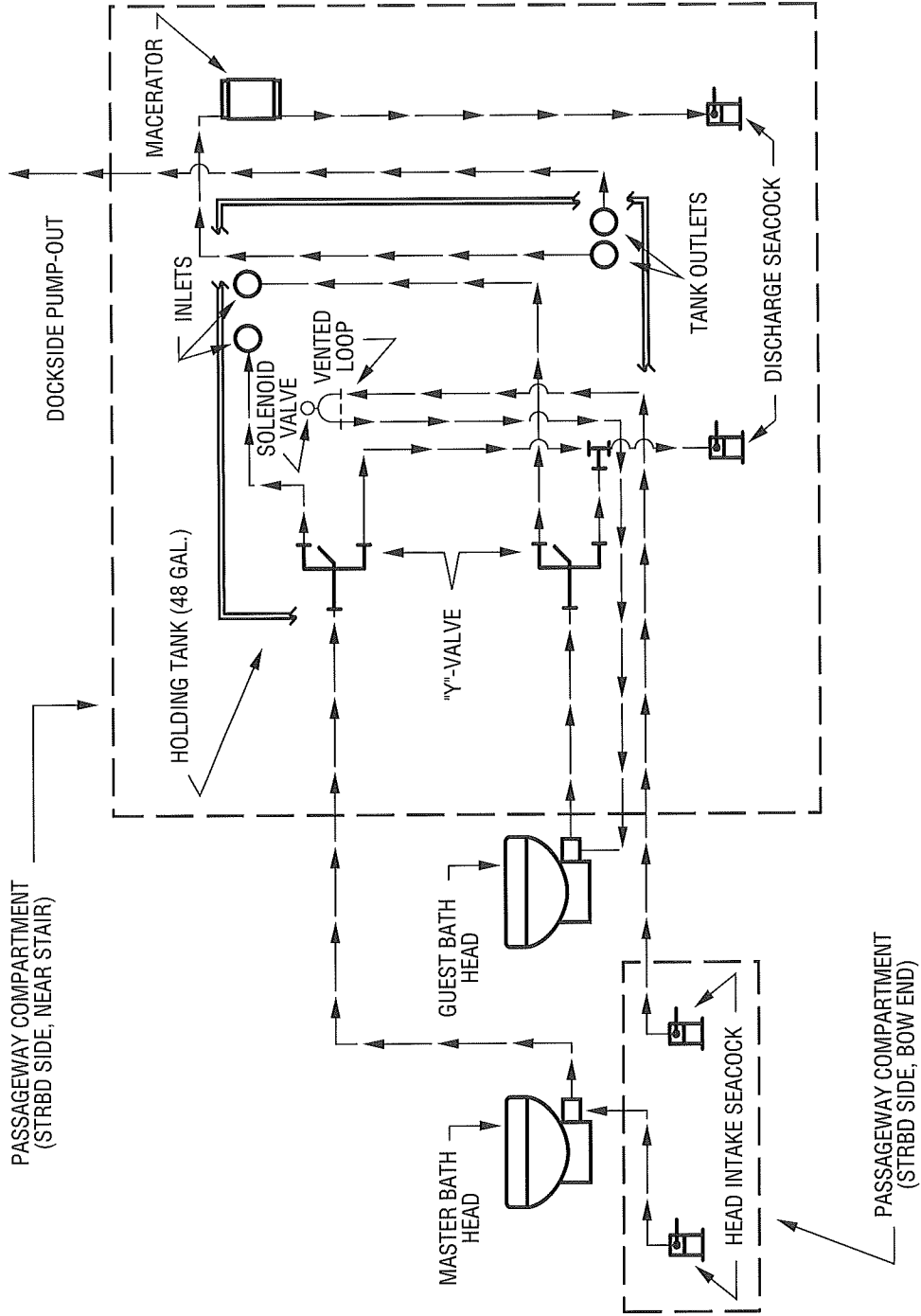

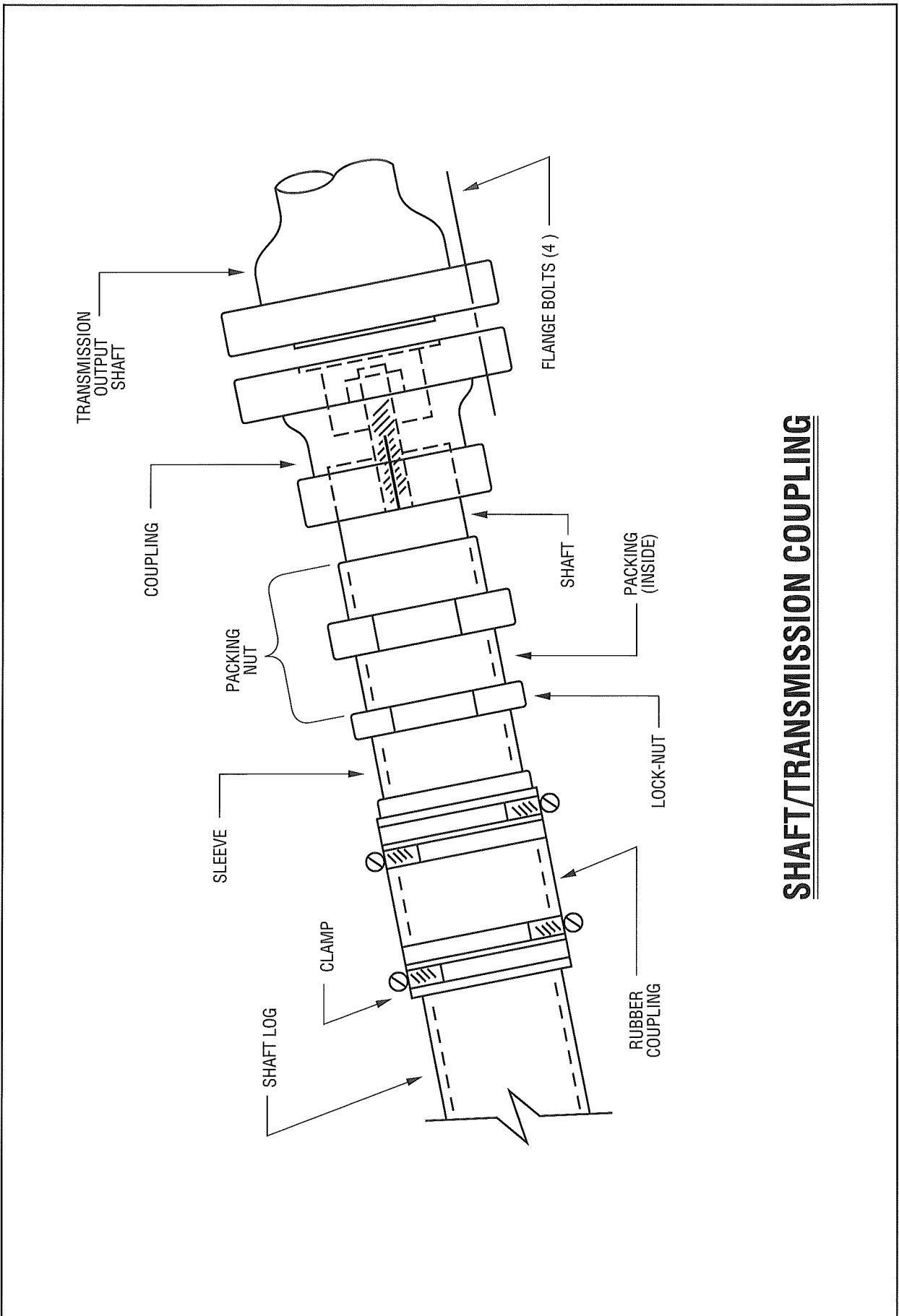

SHAFT/TRANSMISSION COUPLING

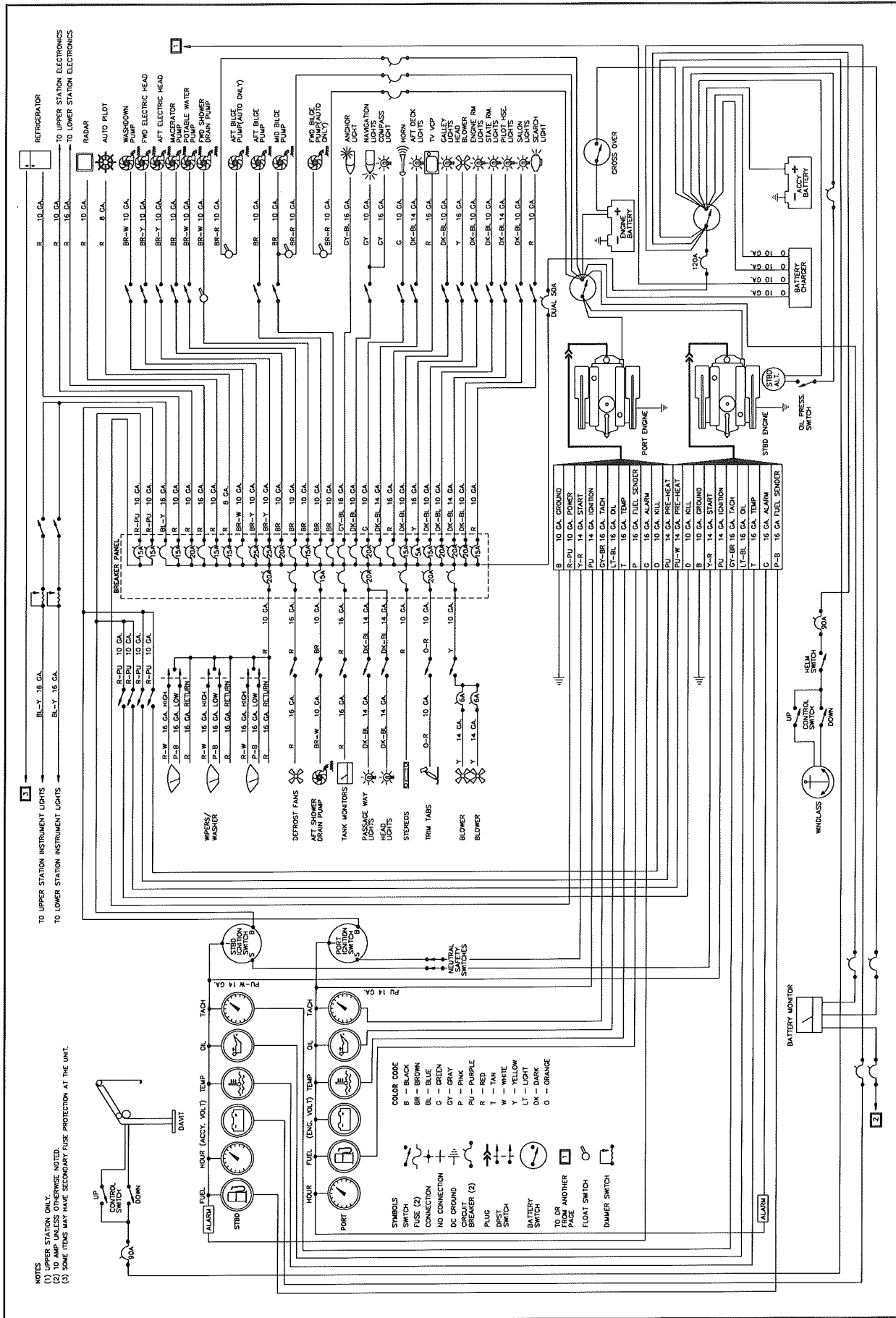

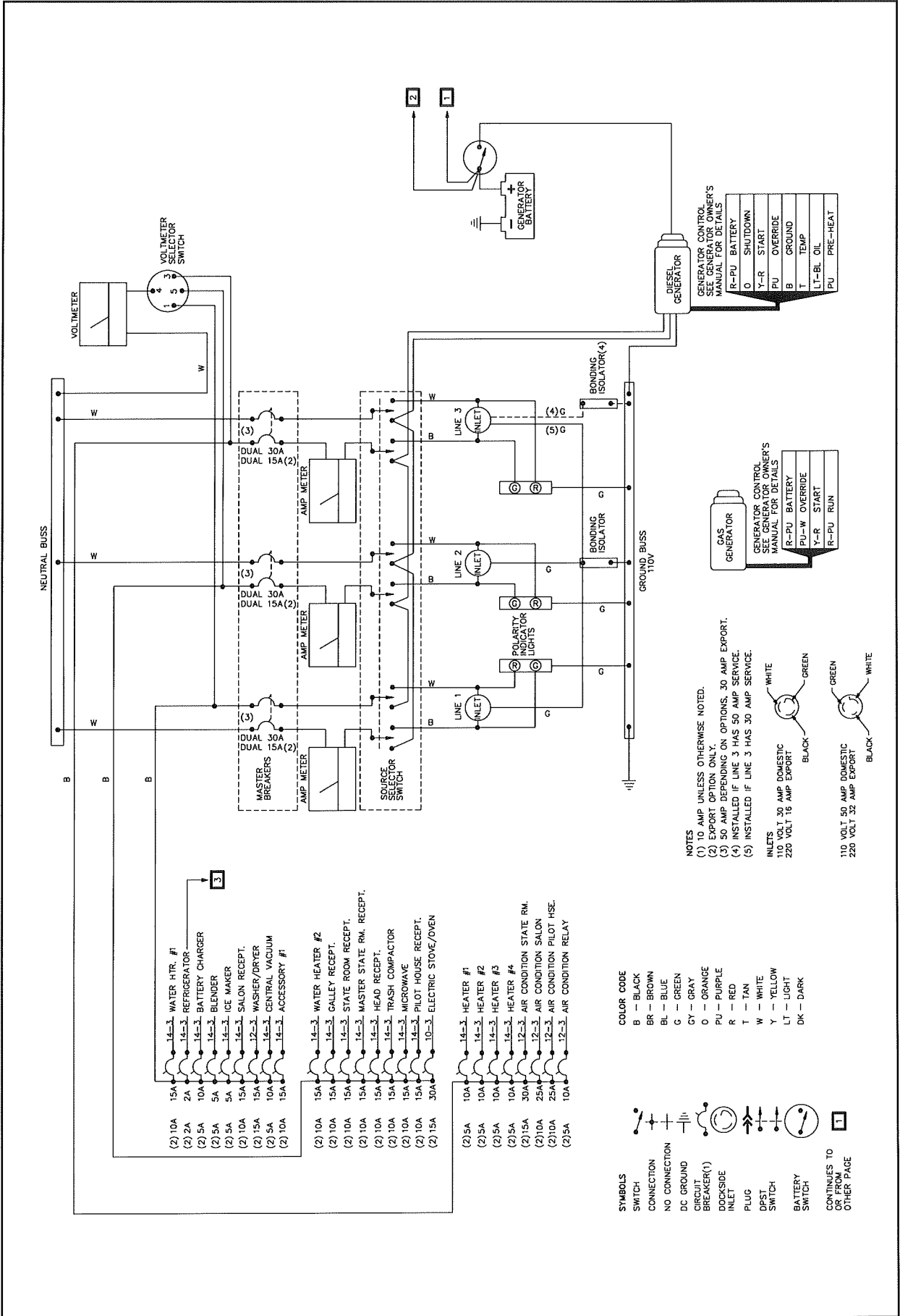

WARRANTY

Limited Warranty

Bayliner warrants to the original purchasers of its 1991 model boats, purchased from an authorized Bayliner dealer, operated under normal, noncommercial use that the Selling Dealer will: (A) Repair any structural hull defect which occurs within five (5) years of the date of delivery; and (B) Repair or replace any parts found to be defective in factory material or workmanship within one (1) year of the date of delivery.

What Is Not Covered

This warranty does not apply to: (1) Engines, drive trains, controls, props, batteries, or other equipment or accessories carrying their own individual warranties; (2) Engines, parts or accessories not installed by Bayliner; (3) Window breakage or leaks; cosmetic gelcoat finish, i.e., discoloration, blisters, cracks or crazing; (4) Hardware, vinyl tops, vinyl and fabric upholstery, plastic, metal, wood or tape trim; (5) Any Bayliner boat which has been altered, subjected to misuse, negligence or accident, or used for racing purposes; (6) Any Bayliner boat which has been overpowered according to the maximum horsepower specifications on the capacity plate provided on each Bayliner outboard boat; (7) Any Bayliner boat used for commercial purposes; (8) Any defect caused by failure of the customer to provide reasonable care and maintenance.

Other Limitations

THERE ARE NO OTHER EXPRESS WARRANTIES ON THIS BOAT. TO THE EXTENT ALLOWED BY LAW:

- 1. Any implied warranty of merchantability is limited to the duration of this written warranty.**
- 2. Neither Bayliner nor the Selling Dealer shall have any responsibility for loss of use of the boat, loss of time, inconvenience, commercial loss or consequential damages.**
3. Some states do not allow limitations on how long any implied warranty lasts, so the above limitation may not apply to you. Some states do not allow the exclusion or limitation of incidental or consequential damages, so the above limitation or exclusion may not apply to you. This warranty gives you specific legal rights, and you may also have other rights which vary from state to state.

Your Obligation

In order to comply with Federal regulations, it is essential that your warranty registration card be submitted within 30 days of delivery of your boat. Return of this card is a condition precedent to warranty coverage. Before any warranty work is performed, we require that you contact your Selling Dealer to request warranty assistance.

We require that you return your boat, at your expense, to your Selling Dealer or, if necessary, to the Bayliner factory. You will be responsible for all transportation, haulouts and other expenses incurred in returning the boat for warranty service.

**Bayliner Marine Corporation
PO Box 9029
Everett, WA 98206
Phone (206) 435-5571**