

# WELCOME ABOARD

---

This manual has been prepared to assist you in the operation and care of your Bayliner boat. Please read through it completely, as familiarization with its contents can contribute to the more effective operation of your boat.

Your Bayliner boat is part of a carefully engineered, power-matched package which includes an engine and trailer designed to provide optimum performance and utility. Installation of a different engine or other accessories, such as trim tabs, may cause undesirable handling characteristics. Should you choose to have a different engine installed, or to add accessories that will affect the boat's running trim, have an experienced marine technician perform a safety inspection and a handling test before operating your boat by yourself.

Your boat's mechanical and electrical systems were designed to meet safety standards in effect at the time the boat was built. Some of these standards were mandated by Federal law, others are considered industry norms. All of them were designed to insure your safety, and the safety of other people, vessels and property around you. **To maintain the integrity and safety of your boat, only qualified people should perform maintenance on, or in any way modify, the steering, propulsion, engine control, fuel, environmental control, or electrical systems.** Failure to maintain these systems as designed could violate Federal law, and could expose you and other people to the danger of bodily injury or accidental death. We recommend that you follow the instructions provided in this handbook, in the engine owner's manual, and in the accessory instruction sheets included with your boat, engine and trailer package. We also recommend that you perform the following steps:

1. Make certain that you receive a full explanation of all systems from the dealer before taking delivery of your boat. Your selling dealer is your key to service. If you experience any problems with your new Bayliner, immediately contact the dealership. If for any reason your selling dealer is unable to help, call us direct on our customer service hotline for assistance. The number is (360) 435-8957.
2. Read this manual thoroughly, paying particular attention to the subjects of **fueling, checking for fumes, starting, carbon monoxide, loading limits, recommendations for safety, and warranty.**
3. Practice—all members of the family should be familiar with the operation and systems of your boat.
4. Participate in a safe boating course. Call the local office of the United States Power Squadrons, the United States Coast Guard Auxiliary, The Red Cross, or your state boating law enforcement agency for the date and location of their next class. Inquires can be made to the Boating Safety Hotline, 1-800-368-5647 or to the Boat U.S. Foundation information number 1-800-336-BOAT.

The hazard warning symbols shown below are used throughout this manual to call attention to potentially dangerous situations which could lead to either personal injury or product damage. We urge you to read these warnings carefully and follow all safety recommendations.

 **DANGER**

The symbol shown above alerts you to immediate hazards which **WILL** cause *severe personal injury or death* if the warning is ignored.

 **WARNING**

The symbol shown above alerts you to hazards or unsafe practices which **COULD** result in *severe personal injury or death* if the warning is ignored.

 **CAUTION**

The symbol shown above alerts you to hazards or unsafe practices which **COULD** result in *minor personal injury, or cause product or property damage* if the warning is ignored.

**NOTICE**

The symbol shown above calls attention to installation, operation, or maintenance information which is important to proper operation, but is not hazard-related.

There is information in this manual related to the following **Bayliner Capri Stern Drive boats:**

---

1750CU	1850CS	1950CL	2050CX	2250BC
	1850BB	1952CN	2050CZ	2250BD
	1851CB	1954CW	2051CC	2252BF
			2052CK	

---

Due to our commitment to product improvement, we reserve the right to change, without notice or other obligation, the specifications or other information contained in this publication.



### **WARNING**

A qualified operator must be in control of the boat at all times. Do not operate your boat while under the influence of alcohol or drugs. Never operate your boat at speeds which exceed your ability to react if an emergency develops. At night, turn on the appropriate navigation lights and cruise at a reduced speed that will allow you plenty of time to avoid dangerous situations.



### **WARNING**

Manufactured with 1,1,1-Trichloroethane, a substance which harms public health and environment by destroying ozone in the upper atmosphere.

**This page is  
intentionally blank**

# Table of Contents

---

<b>WELCOME ABOARD .....</b>	<b>1</b>
<b>PREPARATION .....</b>	<b>7</b>
Recommendations for Safety .....	7
Safety Equipment .....	11
Tool Chest .....	11
Miscellaneous Items .....	11
Trim .....	12
Other Tips .....	12
Trailering .....	12
Launching .....	15
Reloading .....	16
<b>OPERATING .....</b>	<b>17</b>
Fueling Procedures .....	17
Starting .....	18
Carbon Monoxide .....	21
Before You Leave .....	22
Maneuvering .....	23
Basic Maneuvering .....	23
Engine Trimming .....	25
Docking .....	25
Boat Performance .....	27
Boat Running Trim .....	27
Steering Pressure .....	27
Instruments .....	28
<b>COMPONENTS/SYSTEMS .....</b>	<b>29</b>
Electrical System .....	29
Starter Motor .....	31
Bilge Blower .....	31
Bilge Pump .....	32
Navigation Lights .....	34
Fuel System .....	34
Portable Head .....	35
AM/FM Cassette Stereo .....	36
Seat Adjustment .....	37
Canvas Top Installation .....	38
<b>GENERAL MAINTENANCE AND REPAIRS .....</b>	<b>39</b>
Bilges/Engine Compartment .....	39
Cabin and Topside Areas .....	40
Hull .....	42
<b>STORAGE .....</b>	<b>44</b>
<b>NAUTICAL TERMS .....</b>	<b>45</b>
<b>WIRING DIAGRAM .....</b>	<b>46</b>
<b>LIMITED WARRANTY .....</b>	<b>47</b>

**This page is  
intentionally blank**

# PREPARATION

Prior to leaving on your first outing (or, for that matter, any outing) there are certain items to check and activities to perform. Familiarize yourself with your boat before launching, and consider the following suggestions:

## Recommendations for Safety

### 1. Personal Flotation Devices:

One Coast Guard approved personal flotation device (PFD) of suitable size is required for each person aboard a recreational boat. New PFDs bearing Coast Guard approval are now identified as Types I, II, III, or IV.

As of May 1, 1995, you must have on board, regardless of the size boat:

- at least one (1) Type IV (throwable) PFD
- one (1) Type I, II, or III (wearable) PFD for each person on board

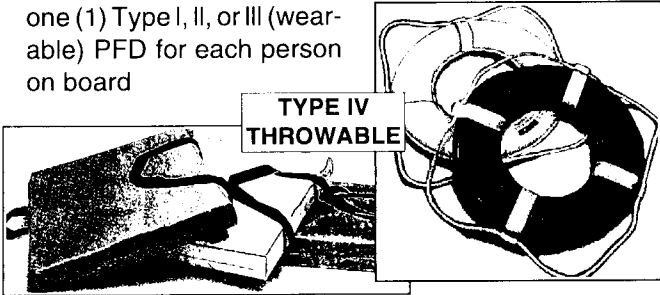
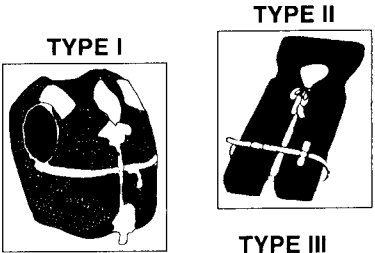

- ### 2. Always have children wear PFDs. Always keep PFD's readily accessible and check those devices intended for young children for fit and performance in the water. Never hesitate to have "all hands" wear lifesaving devices whenever circumstances cause the slightest doubt about safety.



3. Do not exceed the load (in pounds) or people capacity found on the U.S. Coast Guard placard attached to your boat and take care to properly load your boat. Maintain adequate freeboard at all times. Consider the sea conditions, the duration of the trip, the weather and the experience of the personnel on board.
4. The operator of the boat is responsible for the safety of his passengers as well as his own. You should insure that everyone aboard is properly and securely seated in appropriate seating locations before starting. You should not allow sitting on seatbacks, gunnels, bows, transoms, fishing seats, or sun lounges while underway. In many states it is illegal.



## **DANGER**

**Do not allow anyone to ride on parts of the boat that were not designed for such use. Sitting up on seat backs, bow riding, gunwale riding, transom platform riding, or lounging on either forward or aft sundeck cushions while underway is especially hazardous and will cause personal injury or death.**

5. Falls are the greatest cause of injury while afloat. Eliminate tripping hazards where possible, make conspicuous those that must remain, and require that everybody on board wear proper footwear.
6. Boat operators are required by law to file a Boating Accident Report with their state boating law enforcement agency when their boat is involved in certain boating accidents. A boating accident must be reported if (1) there is loss of life or probable loss of life, or (2) there is personal injury requiring medical treatment beyond first aid, or (3) there is property damage to boats or other property where the damage value exceeds \$500.00, or (4) there is complete loss of the boat. For further information and assistance contact the local law enforcement authorities.
7. Never drive the boat directly behind a water skier. At 25 m.p.h. the boat will overtake a fallen skier who was 200 feet in front in 5 seconds.
8. Understand the meanings of navigation buoys, and never moor to one (It is a Federal offense).
9. Know the various distress signals. A recognized distress signal used on small boats is to slowly and repeatedly raise and lower the arms outstretched to each side.
10. Storm signals are for your information and safety. Learn them and be guided accordingly.
11. A special flag (red flag with a white diagonal stripe or white and blue international "Alpha") flown from a boat or buoy means diving operations are underway nearby. Approach with caution and stay clear by at least 25 yards.



12. Make sure your boat's engine is turned off before allowing people to swim anywhere near your boat. Shut the engine OFF and remove the key from the ignition switch so that nobody will accidentally start the engine while swimmers are nearby. Also, slow down and exercise extreme caution any time you are cruising in an area where there might be swimmers or water skiers in the water. Always keep a down skier in sight and on the operator's side of the boat when approaching the skier. Never back up to anyone in the water. Consult your state's laws regarding a skiing observer and the use of a warning flag whenever the skier is down.
13. Watch your wake. It might capsize a small craft. You are responsible for damage caused by your wake. Pass through anchorages at a minimum speed.
14. Learn and abide by common boating "rules of the road".
15. Always have up-to-date charts of your cruising area on board.
16. Keep an alert lookout. The operator is required by law to "maintain a proper lookout by sight (and hearing). He must insist that he has an unobstructed view particularly to the front. No passengers, load or fishing seats should block his view when operating the boat above idle speed.
17. Always instruct at least one person on board in the basics of boat handling in case you are disabled or fall overboard.
18. Consider what action you would take under various emergency conditions such as a person overboard, fog, fire, a damaged hull or other bad leaks, engine breakdown, severe storm or collision.
19. If your boat ever capsizes, remember that if it continues to float (if not overloaded, powerboats less than 20' in length will float when swamped), it is usually best to remain with it. You are more easily located by a search plane or boat.
20. Keep fire fighting and lifesaving equipment in good condition and readily available at all times.
21. Do not test fire extinguishers by squirting small amounts of the agent. The extinguisher might not work when needed. Always follow approved instructions when checking fire extinguishers.
22. Have an adequate anchor and sufficient line (at least six times the depth of the water) to assure a secure hold in all types of weather and sea conditions.
23. Boat hooks are valuable when docking or retrieving objects that have fallen overboard.



## **DANGER**

**NEVER substitute automotive parts for marine parts. Electrical, ignition and fuel system parts on your boat are designed and manufactured to comply with U.S. Coast Guard Rules and Regulations to minimize risks of fire and explosion.**



## **DANGER**

**Knife switches or other arcing devices should NEVER be installed in fuel compartments**

24. Keep electrical equipment and wiring in good condition. Knife switches or other arcing devices should **never** be installed in fuel compartments. Allow ample ventilation around batteries.
25. Good housekeeping in your boat is important. Cleanliness diminishes the probability of fire.
26. Know your fuel tank capacity and cruising range. If it is necessary to carry additional fuel, do so only in proper containers. Take special precautions to prevent the accumulation of fuel vapors in confined spaces.



## **WARNING**

**Fuel vapors are explosive. Do not store portable fuel containers in unventilated locations. The vapors would be trapped and might be ignited accidentally.**

27. Before departing on a boat trip, advise a responsible friend or relative about where you intend to cruise. Be sure to give that person a good description of your boat. Keep them advised of any changes in your cruise plans. These precautions will enable your friend or relative to tell the Coast Guard where to search for you and what type of boat to look for if you fail to return. Be sure to advise the same person when you complete your trip to prevent any false alarms about your safety.
28. Your local United States Coast Guard Auxiliary, the United States Power Squadrons, The Red Cross, and your state boating law enforcement agency offer safe boating classes several times a year. These are comprehensive courses, and are generally of minimal cost to you. Call your local U.S. Coast Guard Auxiliary, Power Squadron Flotilla, or your state agency for the time and place of their next class. Inquiries can be made to the Boating Safety Hotline, 1-800-368-5647 or to the Boat U.S. Foundation information number 1-800-336-BOAT.

## **Safety Equipment**

---

The following safety-related items should be considered as part of your standard equipment:

1. Fire extinguishers (correct number and type, located for easy access)
2. Personal flotation devices
3. Fenders, lines and boat hook
4. Flares (night and day type with unexpired dates)
5. Flashlight(s) with extra batteries
6. Charts of your intended cruising area
7. First aid kit
8. Anchor and adequate line

## **Tool Chest**

---

1. Assorted screwdrivers (Phillips and flat blade)
2. Pliers (regular, vise-grip, and water pump)
3. Wrenches (box, open-end, allen, adjustable, include one wrench large enough, 1  $\frac{1}{16}$ " , to fit the prop nut )
4. Socket set (metric or U.S. standard as appropriate)
5. Hacksaw with spare blades
6. Hammer
7. Battery jumper cables
8. Electrical tape
9. Assorted fasteners
10. Gear grease and penetrating oil

## **Miscellaneous Items**

---

1. Engine and accessories manual
2. Spare propeller with fastening hardware
3. Extra V-belts
4. Engine lubricating oil
5. Spare fuel and oil filters
6. An extra cooling pump impeller
7. Replacement light bulbs
8. Spare set of spark plugs and other ignition parts
9. An assortment of spare fuses

## Trim

---

*Trim* refers to the way your boat floats in the water. When floating properly as designed, it is on an *Even Keel*. If it inclines to port or starboard, it *Lists*. If loaded too heavily forward, it *Trims By The Head* (or is *Down By The Bow*). If it's draft is excessive aft, it *Trims By The Stern* (is *Down By The Stern*).

Your boat's trim can be affected by many variables such as optional equipment and loading of gear or cargo. Load gear and cargo as evenly as possible. If necessary, move heavy items to the opposite side (or end) to achieve proper trim.

## Other Tips

---

1. When commissioning a new boat, do not plan an extensive trip or outing until you have had a shakedown cruise to make sure all equipment on your boat is functioning properly and you are familiar with its operation.
2. Use big fenders or fender boards to protect your boat's hull whenever mooring next to floats, piers, or other boats.
3. Carry plenty of line that is properly sized to your boat. We suggest at least two 30' lengths of 3/8" nylon line.

## Trailer

---

An important part of your recreational boat package is your trailer, which was specifically designed for your boat. We recommend that you read your Trailer Owner's Manual thoroughly and become familiar with your trailer's features before towing or launching your boat. The following information highlights several things you will want to consider when trailering your boat.

1. Check the wheel bearings for smooth operation and proper amount of grease before and after the first several times you tow your trailer. Make it a habit to check the bearings at least every 90 days after that. Also, you'll want to clean, inspect and repack the bearings with grease before storing your trailer over the winter, or any other time you plan to store the trailer for an extended period of time. Make it a habit to feel the wheel hubs each time you stop for gas or refreshments. If the hub feels abnormally hot, it may indicate bearing trouble. Allow the hub to cool and inspect the bearings to determine the problem. It is wise to have a spare set of wheel bearings, races, seals and cotter keys in case you need to replace them on the road.
2. Check that the tires are properly inflated for the load the trailer will be carrying prior to each trip. Underinflated tires will heat up rapidly and tire damage is likely to occur. You should carry a spare wheel and tire, which also should be checked for proper inflation before each trip. Don't forget to bring along a jack and any tools necessary for changing the tire.

3. Check the wheel lug nuts for security before each trip.
4. Check the trailer's brakes for proper operation prior to each trip. Consult your state laws for trailer brake requirements and make sure your trailer is properly equipped (laws vary from state to state).
5. Check the trailer's undercarriage for loose parts. Also check the springs for proper operation or possible damage.
6. Examine the wire harness connector plug for corrosion or broken prongs. Once you have hooked the trailer to your tow vehicle, perform a functional test of the lights to verify that they work properly. Some autos will require heavy-duty flasher units to make turn signals operate properly, so you may wish to consult your auto dealer's service department for their recommendations.
7. Prepare your boat for trailering by closing all cabin windows and doors. Make sure the stern drive is tilted into the manufacturer's recommended trailering position. Canvas tops are not designed to withstand the loads created by highway speeds, so take down all tops, side curtains, and slant or camper covers. Stow them in a secure location so they won't blow out of the boat while on the highway. Make sure the engine compartment cover is securely latched down and the rest of your equipment is distributed evenly and stowed securely. The load should be balanced, as too much or too little weight on the trailer's tongue will cause difficult steering and tow vehicle sway. A rough rule of thumb is that 5% to 10% of the boat and trailer weight should rest on the tongue. Do not load your boat so that the gross weight rating of your trailer is exceeded.
8. Check the condition of towing safety chains, transom tie-down straps and winch cables. Replace any that appear worn or unsafe. Your boat should be fastened to the trailer by a line or cable from the winch to the boat's bow eye **and** a safety chain from the winch stand or trailer tongue to the boat's bow eye. The transom straps should be fastened from the left and right trailer frame members to the boat's transom-mounted trailering eyes. Make sure the straps are snugged down securely.

## **NOTICE**

**The transom tie-down straps and winch cables are designed for normal towing conditions on paved roads and fairly smooth secondary roads (at slow speeds only). They should not be relied upon for any lifting application. Also, we recommend the use of additional straps or rope tie-downs for securing your boat to the trailer, especially for longer trips or whenever you expect to encounter rough roads. If in doubt, use extra straps.**

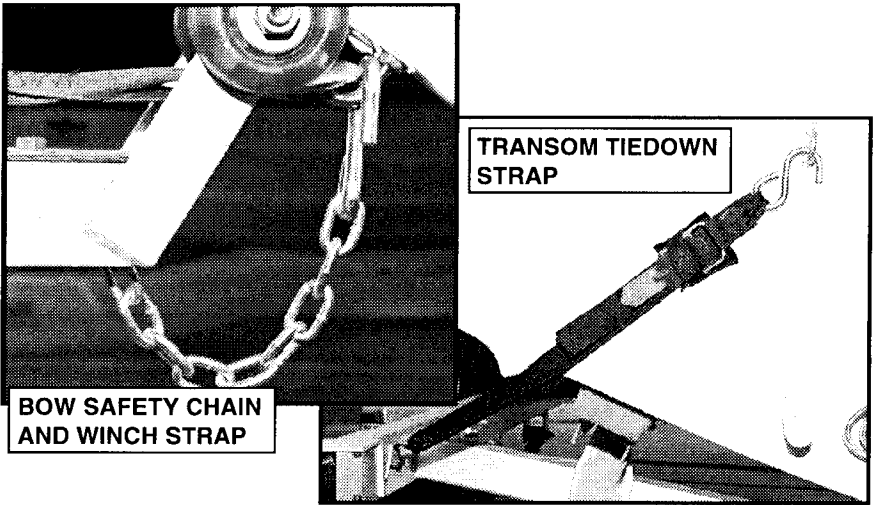

**⚠ WARNING**

**Failure to use safety chains between the trailer and the towing vehicle and adequate tie-down straps to hold the boat to the trailer can cause serious accidents. Not using these safety devices can allow the boat and or trailer to come loose while being towed.**

Once all your safety checks have been completed, you will be ready to head for the water. However, we highly recommend that you tow your boat to a nearby empty parking lot first and practice maneuvering your trailer until you feel comfortable with it. It helps to have someone to direct you any time you are backing the trailer. If your tow vehicle is not already so equipped, consider installing a right side mirror for improved rearward visibility.

Your tow vehicle will take longer to accelerate and will require more distance to slow down when trailering a boat. Don't tailgate the vehicle ahead of you, as you'll risk "jackknifing" if you should have to stop in an emergency. Open up your following distance from the normal two second interval to at least three or four seconds between your vehicle and the one ahead. Allow even more space in rainy or icy conditions, or at night. Remember to swing wide as you turn to avoid cutting the corner; avoid making any sharp turns.

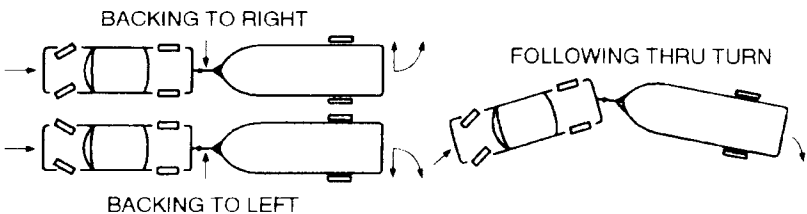

## Launching

---

When you arrive at the launching ramp and are ready to float your boat off the trailer, make these basic checks to be certain that the launching is a safe operation.

1. Disconnect the trailer's wire harness connector plug from the tow vehicle. This will greatly reduce the chance of blowing out your trailer lights when they become submerged.
2. Feel the trailer's wheel hubs to check for hot bearings. Submerging hot hubs in cold water causes water to be drawn into the bearing caps, so it is best to allow the hubs to cool before proceeding with the launching.
3. Install the hull drain plug at the bottom of the transom. Make sure you tighten it securely.

 <b>CAUTION</b>
--

<b>Failure to install the drain plug securely will result in the boat filling with water when it is launched.</b>
---

4. Remove and stow the transom trailering straps. Remove the safety chain from the bow eye. In order to maintain control of the boat as it is launched, secure a mooring line of adequate length to the boat's bow cleat and have someone wearing their life jacket hold the other end of the line as you back the trailer into the water.
5. Carefully back the trailer down the ramp until the boat floats free. The idea is to back the trailer far enough into the water to float the boat, but not so far that you submerge the back end of the tow vehicle. If you are launching the boat yourself, remember to set the tow vehicle's emergency brake, place the transmission in PARK (for manual transmissions, shift to FIRST gear and shut the engine OFF), and block both front tires immediately upon leaving the vehicle.
6. Loosen the winch and release the winch cable from the bow eye. Tie your boat to the dock with the line from the bow cleat. Immediately board the boat and inspect the lower compartments, ski locker and bilge areas for any sign of leakage. If you find that the boat is taking on water, immediately guide the boat back to the trailer and remove it from the water (see reloading instructions that follow). Pull away from the ramp so others might use it and locate the problem before relaunching the boat. If you cannot find the cause of the leakage, notify your selling dealer for further assistance.
7. Once your boat is tied off and you have verified that it is not leaking, carefully pull your trailer clear of the water and park your tow vehicle in an appropriate designated area. Then proceed with starting the boat's engine as instructed in the engine owner's manual.

## Reloading

---

1. To reload your boat onto the trailer, back the trailer into the water until about two-thirds of the bunk assembly is submerged. Don't forget to set the tow vehicle's emergency brake, place the transmission in PARK (for manual transmissions, shift to FIRST gear and shut the engine OFF), and block both front tires immediately upon leaving the vehicle. Passengers should disembark prior to retrieval of the boat.
2. An experienced operator should carefully motor the boat onto the partially submerged trailer at idle speed. Exercise extreme caution when approaching the trailer. **DO NOT** power the boat all the way up onto the trailer bunks, as this can cause damage to the boat, engine or trailer. As you proceed forward slowly, the trailer bunks will guide your boat onto the trailer far enough to allow someone to hook the winch cable to the boat's bow eye after you have placed the boat's shifter in the NEUTRAL position and shut down the engine. Use the winch to apply enough tension on the cable to hold the boat in place.
3. Tilt the stern drive up to the trailering position so it won't be damaged when the boat is pulled up onto the trailer.
4. Make sure nobody is standing between the boat's bow and the winch, then use the winch to pull the boat onto the trailer until its bow rests against the trailer's bow stop roller.
5. Secure the bow safety chain from the winch stand or trailer tongue to the boat's bow eye. After making certain that all bystanders are out of the way, remove the wheel blocks, release the tow vehicle's emergency brake, and tow the boat clear of the launch ramp so others may use it.
6. Keeping in mind the trailering inspection items mentioned previously, prepare your boat and trailer for the road. Don't forget to remove the drain plug and store it in a safe place; this will allow the water to empty from the boat as you travel home.
7. Refer to your Trailer Owner's Manual for maintenance and storage details, as well as more specific information concerning other aspects of trailering.



# OPERATING

## Fueling Procedures

### **WARNING**

Fuel vapors are explosive and can become trapped in the lower portions of a boat where they might be ignited accidentally. While fueling, all doors, hatches, and portlights must be closed.

### **WARNING**

Do not use fuels that incorporate any form of alcohol or alcohol derivatives. Alcohol destroys marine fuel system hoses and components, which could lead to hazardous leaks, fire or explosion.

### FUEL CAPACITY TABLE

Model	Tank Capacity (Gallons)
1750 Capri CU -----	20
1850 Capri CS -----	30
1850 Capri BB -----	30
1851 Capri CB -----	30
1950 Capri CL -----	25
1952 Capri CN -----	25
1954 Capri CW -----	25
2050 Capri CX -----	35
2050 Capri CZ -----	35
2051 Capri CC -----	35
2052 Capri CK -----	35
2250 Capri BC -----	60
2250 Capri BD -----	60
2252 Capri BF -----	60

### **NOTICE**

The listed capacities are the dry volume capacity of the tank. Each tank is vented internally to allow air to escape as the tank is filled. A portion of the volume will include air trapped inside the tank; therefore it is not usually possible to fill the boat's fuel tank to its dry volume capacity.

## Fueling Procedures, continued

---

1. If you're going to fuel your boat while it's in the water, be sure it's securely moored to the dock.
2. Turn off all electrical equipment including engines, appliances, bilge blower, lights, etc.
3. Extinguish all cigarettes, cigars or other items that may produce a spark or flame.
4. Close all openings including hatches, windows, doors, and portlights.
5. Through-deck fittings are provided for fuel tank filling. Remove the cap and insert the fuel supply nozzle, allowing the nozzle to maintain contact with the fitting; this will prevent possible static sparking.
6. Often you won't be able to fill the fuel tank to 100% of its dry-rated capacity. This is because the amount of fuel the tank will hold depends, in part, on the boat's floating attitude, which in turn affects the position of the fuel tank and its venting system. If fuel flows out the tank vent, discontinue fueling immediately. The tank will be as full as possible under the current conditions. It is advisable not to overfill the tank anyway, as you want to allow for thermal expansion of the fuel, especially on very hot days.
7. If, when filling the tank, you can't put fuel in at a reasonable rate, check the fuel vent line to see that it's not kinked or plugged.
8. When you have finished fueling, replace the fill cap and wipe off any fuel spillage.
9. Open the engine compartment and all windows, doors, and hatches; inspect, both visually and by smell, for fuel fumes or leakage. Any sign of fuel leakage, or any indication of fumes, must be investigated and corrected prior to starting the engine.

## Starting

---

The engine operating and maintenance manual furnished with your engine describes prestart and starting procedures. The following notes are basic reminders, and are not intended to cover every detail of engine starting. We urge you to thoroughly read and understand your engine owner's manual.

1. Check the lubricating and cooling fluid levels.
2. Visually check for fuel, oil, coolant, and exhaust leaks.
3. Make sure the emergency engine shutdown triggering device is in place and the lanyard is attached to the operator. This device, when properly attached, turns off the engine ignition whenever the operator moves far enough away from the operator's position to activate the switch. It is strongly recommended that the operator use this device.

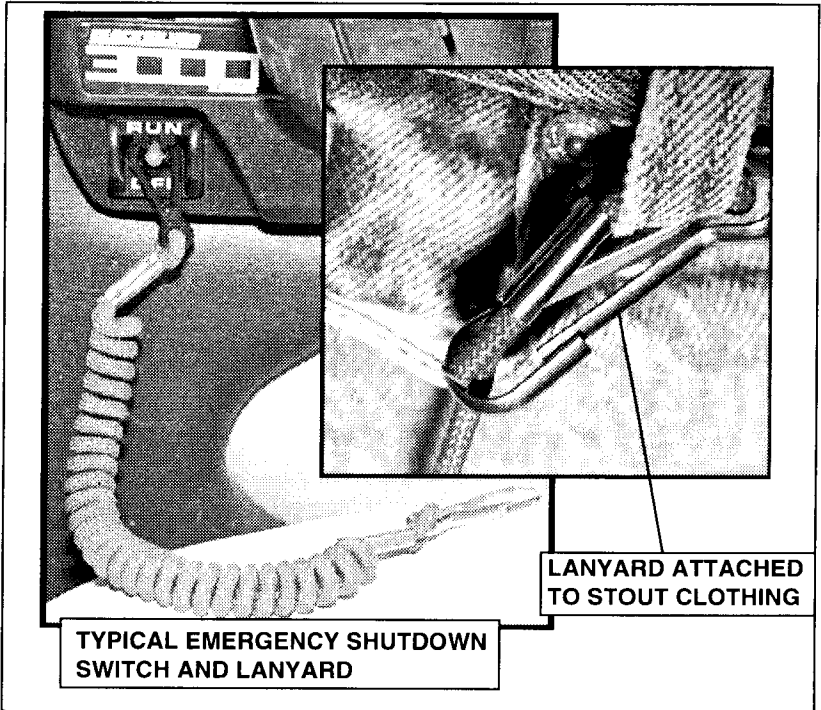

**⚠ WARNING**

A serious accident can occur if the emergency engine shutoff switch lanyard is not fastened to the boat operator. In order for the emergency engine shutdown system to operate correctly, the lanyard must be physically attached to the operator (around the wrist or securely fastened to a stout piece of clothing, such as a belt loop etc.).

4. Run the bilge blower for at least four minutes prior to starting the engine. Leave the blower on until the boat is underway and up to cruising speed, then turn it off.

**⚠ WARNING**

Gasoline vapors are highly explosive. To prevent a possible explosion and fire, check the engine and fuel compartments before each engine start for fumes or accumulation of fuel. Always operate the bilge blower for at least four minutes before engine starting, during the starting process and anytime you are operating your boat below cruising speeds.

5. Before starting the engine, ensure your boat is in deep enough water to lower the stern drive unit. Lower the stern drive unit down to its normal running trim position by activating the trim switch on the throttle lever's handle.
6. With the throttle lever in NEUTRAL, push in the "Throttle Only Button" to permit throttle travel in NEUTRAL without engaging the transmission. Next, move the throttle lever forward to the full open position, then pull it back to the  $\frac{1}{4}$  open position and leave it there.
7. Turn the ignition key clockwise to start the engine, releasing the key when the engine starts. Most stern drive engines will choke automatically when you set the throttle as described in the previous step, though you should refer to the engine owner's manual for the exact procedure that applies to your engine.
8. DO NOT continuously operate the starter for more than 15 seconds at a time. Allow at least one minute for cooling between start attempts.
9. Warning alarms may activate upon engine start. These devices are intended to call your attention to the condition of one or more of the engine's subsystems. Generally, there are two times when warning alarms will sound. The first is upon initial engine start, where the alarm will sound from about 7 to 14 seconds. This indicates that the warning system is working so that if a malfunction occurs later, you can be fairly certain the alarm will sound again to alert you to the problem. The other situation where you'll hear an alarm is when there is actually something wrong with one of the engine subsystems. Conditions that will cause an alarm to sound are high engine coolant temperature, low engine oil pressure, or low oil level in either the stern drive unit or oil injection supply bottle. The exact meaning of each alarm varies depending on the engine manufacturer, and not every engine has all of the alarms mentioned above. We recommend that you refer to the engine owner's manual that came with your engine for more specific information.
10. Check the oil pressure, voltmeter and temperature gauges immediately after the engine starts. Also inspect the engine compartment for fuel, cooling, or exhaust system leaks that were not apparent before you started the engine.
11. Once the engine has been started, allow it to warm-up for several minutes before getting underway.
12. Check steering operation by turning the steering wheel full port and starboard while observing the stern drive movement. Regularly check the original SELF-LOCKING nuts on the "steering link rod" between the steering cable and the engine. These nuts must never be replaced by common or non-self-locking nuts which can vibrate off. Have your dealer check your steering system at least annually for proper lubrication, any unusual backlash, and any unusual component wear.

13. While the boat is still securely moored to the dock, advance the shift control to forward, to reverse, and into neutral to check shifting operation.

## Carbon Monoxide (CO)

---

 <b>DANGER</b>
<p><b>Carbon monoxide (CO) is a poisonous gas that is colorless, odorless and about the same weight as air. It will distribute itself throughout spaces of the boat in dangerous concentrations if proper ventilation is not provided. A person breathing these fumes will become seriously ill. Direct and prolonged exposure will cause brain damage or death. Always run the bilge blower whenever the engine is idling. Opening windows or hatches may improve ventilation. Also, never operate the engine when either the slant cover or the camper cover is installed.</b></p>

Because CO diffuses in the air much more rapidly than easily detectable gases you cannot rely on sight or smell to recognize its presence. CO will be produced anytime materials containing carbon are burned. Common sources of CO are internal combustion engines and open flame devices such as cooking ranges, space heaters, and charcoal grills.

The symptoms of CO poisoning include but are not limited to the following:

1. Watering and itchy eyes
2. Flushed appearance
3. Inattentiveness and the inability to think clearly
4. Ringing in the ears
5. Tightness in the chest
6. Headache and/or throbbing temples
7. Drowsiness and fatigue
8. Incoherence
9. Nausea and/or vomiting
10. Dizziness
11. Collapse
12. Convulsions

If someone is suffering from CO poisoning move the person to fresh air, administer oxygen if available, and contact medical help. If the victim is not breathing perform approved CPR procedures until medical help arrives and takes over.

To help prevent exposure to CO check that ventilation systems are operating properly and for any exhaust leaks. Also be aware of your surroundings. Running your engine or generator in a confined space such as a boathouse or next to a seawall can allow dangerous accumulations of CO. Another boat with an engine running moored nearby can also expose you to dangerous amounts of CO. Be sure that while underway there is a good flow of fresh air through the boat by opening a forward hatch and companion way doors and that exhaust fumes are not being pulled up into the boat by "backdrafting". The incidence of backdrafting increases when:

- Canvas is installed
- Underway with the wind at your back (running with the wind)
- Operating the boat with a bow up trim angle

Gasoline portable generator sets produce CO. These units discharge their exhaust where they are located which can lead to the accumulation of CO in the area. This equipment should **never** be used on recreational vessels.

## Before You Leave

---

If you have not encountered any problems, you are almost ready to go. (If you did encounter problems, do not attempt to operate your boat until they are corrected.) Before you leave, perform the following steps:

1. Check the operation of equipment such as bilge pumps, running lights, wipers, radios, etc.
2. Instruct passengers in the use and location of flotation devices and fire extinguishers.
3. Obtain a reliable weather forecast and plan accordingly for everyone's comfort and safety.
4. Notify a responsible friend or relative of your cruise plans. Upon your return or a change in your cruise schedule, notify that person again in order to avoid unnecessary concern.

## Maneuvering

---

When all of your predeparture checks have been completed, you will be ready to leave the dock.

### Basic Maneuvering

---

Your boat features a "modified-vee" planing hull that has several handling characteristics you should be aware of.

Steering the boat at either idling or cruising speeds will generally require minimal effort. However, operating at a speed just below that required to get the hull on plane may produce substantial steering torque. This is a normal condition, though you should not continue to operate the boat at this speed. Instead, continue accelerating until the boat is on plane, where the amount of steering torque will return to normal.

Your boat may wander slightly from port to starboard when operating at idle speed in forward gear. This is a natural characteristic of modified-vee hulls and shouldn't be cause for concern. Simply correct for this wander with small steering adjustments until you get up to cruising speed. Avoid the tendency to over correct for a wandering condition.

Another characteristic you may notice is that the steering wheel may pull in one direction or the other, depending on whether the boat is traveling in forward or reverse gear. This is caused by a non horizontal prop shaft angle, which causes the stern of the boat to be pulled to one side as power increases, especially when starting from a fully stopped position. Again, this is a normal condition that may be minimized by adjusting the trim angle of the prop shaft on boats equipped with power trim and by adjusting the steering torque tab or trim tab on the stern drive. Boats with power steering do not require a steering torque tab. See your engine owner's manual for detailed information. Practicing maneuvers at slow speeds will help you to become familiar with all the special handling characteristics associated with your boat.



### **WARNING**

**Do not attempt any maintenance or adjustments to the engine or stern drive unit while the engine is running. Failure to shut off the engine for maintenance or adjustments may cause injury or death.**

Remember that all boats steer by the stern (the feeling is much like steering your automobile in reverse). This means that the stern of your boat will swing in the direction opposite to your turn. For example, when you turn the helm wheel to the left, the stern of the boat will swing to the right as the boat goes into a left turn. This is especially important to keep in mind when docking, when operating in close quarters with other boats, or when approaching a swimmer or downed skier in the water.

Always use extreme caution when approaching someone in the water. **NEVER** back up to anyone in the water. Approach them at idle speed only, allowing your stern to swing away from them as you get close. Place the shifter in NEUTRAL and shut off the boat's engine when you are still several feet from the person in the water. While they are swimming over to the boat, lower the swim ladder from the transom platform so they can board. Once everyone is aboard, return the swim ladder to its stowed position and check that everyone is safely seated before restarting the engine. If you are unfamiliar with picking up swimmers in the water, practice this maneuver with a retrievable floating object before attempting it under actual conditions.

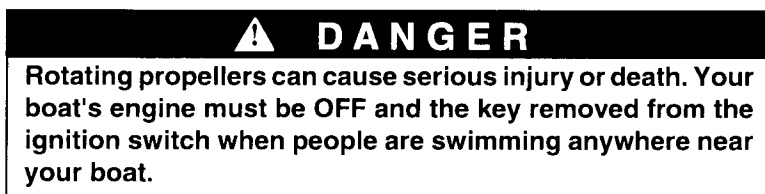

Boats do not have brakes. Stopping is accomplished by backing down on the throttle. Once the boat has slowed and the engine is idling, you can place the shifter in REVERSE. Gradually increasing reverse power with the throttle will allow you to stop the boat in a very short distance. Note that a boat will not respond to steering in reverse nearly as well as it does when going forward, so do not expect to accomplish tight turning maneuvers when backing up.

Once you are away from the dock, devote some time to learning how to maneuver.

- Practice docking by using an imaginary dock.
- Practice stopping and reversing.
- When operating in close quarters or docking, all maneuvering should be done at idle speed. Proceed with caution in congested areas.
- Gradually increase your speed. Get used to the boat before attempting any full throttle operation.



## Engine Trimming

---

The engine on your boat is equipped with power trim. You can change the angle of your prop shaft by pressing the trim switch on the shifter/throttle lever. For an explanation of the handling characteristics caused by trimming your engine see your engine owner's manual.

### *Bow steering:*

Your boat is designed to give you quick acceleration with a minimum of time spent in the bow-up transitional planing off condition. Planing your boat is most easily and quickly accomplished by trimming the engine fully "under" or "in". Moderate to maximum throttle may be required depending on engine height and propeller. However, once on plane, the engine should be trimmed out a little to avoid a bow down condition called "plowing". Plowing can cause "bow-steering" or "oversteering" and increase fuel consumption. In this condition, if attempting a turn or encountering diagonal waves, a more abrupt turn than intended may result.

## Docking

---

### *Preparation:*

Proper docking requires preparation. Start by making sure you have adequate mooring gear, and that it is stowed correctly and ready for use. Your dealer is the best source for information concerning the amount and type of equipment you should carry.

### *Approaching the Dock:*

When approaching a mooring area, lower your speed within a reasonable distance to allow your wake to subside before it reaches other boats or docks. As you get close to your moorage, check for any wind or current action that may affect your maneuver; then make a conservative approach with these factors in mind. Try to use the elements to your advantage. Allow them to carry the boat into the dock. If there are high winds or strong currents, it is best to approach the moorage against the wind or current, called the lee side. With a mild current and little or no wind, it is best to approach with the wind or current, called the windward side. While approaching, check to see that all lines are attached to the cleats on the side facing the moorage. Also insure that fenders are lowered on that side. Be sure to check that the fenders are hung at the proper height.

As you approach your moorage, it is desirable to have one person at the bow and one at the stern of the boat, each with a boat hook and a mooring line attached to a cleat. Approach at idle RPM at an angle approximately 45 degrees to the dock. When the bow is within a few feet of the dock (starboard side) the stern can be brought alongside the moorage by turning hard to port. Next, turn to starboard and at idle RPM put the boat into REVERSE. This will stop the boat and bring the stern even closer to the dock. These steps are reversed for docking to port.

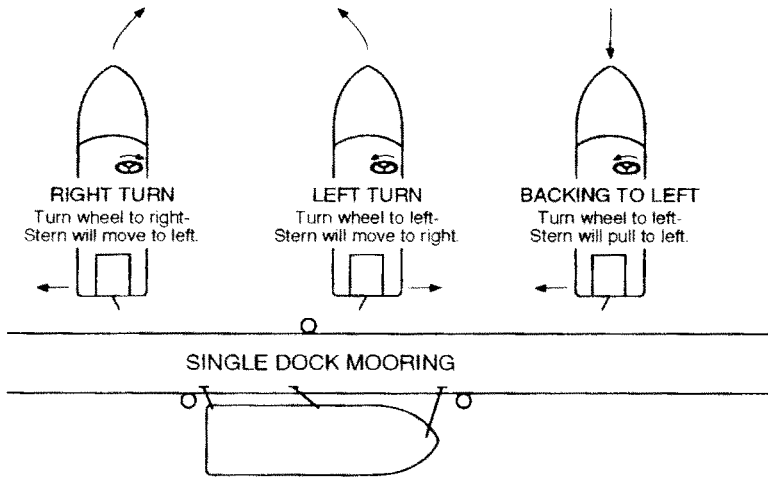

*Mooring:*

To attach lines to deck cleats, tie or splice a loop in one end of the line and pass it through the hole in the base of the cleat; then pass the loop back over the entire cleat. The line can now be used to secure your boat. Lines may be kept this way while underway as long as they are coiled and cannot become fouled in deck gear or props. In heavy sea conditions, all lines should be removed from the deck.

 <b>WARNING</b>
<p><b>Whenever you are towing another boat, or having your boat towed, make sure the towline is fastened securely to the bow or transom towing eyes only. Never attach a towline to deck cleats as serious injury may result if the cleats pull free from the deck. Also, to reduce the danger created by a potential failure of the towline, everyone should stay well clear of the towline attachment points on both the towing and the towed boats.</b></p>

*Leaving the Dock:*

Take into account wind, tide, current, and other forces that affect your maneuvering as you leave the dock. Most maneuvering to and from a dock is best accomplished at idle speeds.

Do not forget to release the mooring lines and stow the fenders. When leaving a moorage on your starboard side and your bow cannot be pushed away from the dock first, start forward with the helm wheel turned to

starboard for two or three feet. Then shift to REVERSE with steering full to port. Repeat if necessary to get the stern far enough away from the dock so you can back clear of any other boats that may be moored ahead of you. (Reverse steering wheel directions when leaving a dock located to port.)

## **Boat Performance**

---

Boat speeds are affected by a great many factors. Some, such as temperature and altitude, you cannot change, but some factors you can:

1. **Loading:** Take only necessary equipment with you. Keep weight low in the boat and balanced.
2. **Propeller:** Keep it in good repair and at the correct pitch for your particular situation. The factory standard equipment propeller may not be the best for your particular boat and load conditions. If the engine RPM at full throttle is greater or less than its maximum rating, ask your Bayliner dealer about trying a different prop.

A slightly bent or nicked propeller will adversely affect the performance of your boat.

3. **Weeds, barnacles and other growth:** Keep your boat's bottom clean. When your boat starts "growing grass", it will slow down greatly.

## **Boat Running Trim**

---

1. If your boat runs with its bow too high at cruising speeds, the following suggestions will help you achieve a more correct cruising trim:
  - Move some weight forward in the boat.
  - Adjust the thrust angle of the stern drive (reduce the distance between the bottom of the transom and the stern drive). See your engine owner's manual for trimming instructions.
2. If your boat runs with its bow too low at cruising speeds (usually indicated by water coming off the hull far forward and steering difficulty or veering off course), you can raise the bow by performing steps opposite of those above.

## **Steering Pressure**

---

As mentioned earlier in the basic maneuvering section, the boat's steering will usually pull to one side or the other to some degree. This effect is caused by a non-horizontal prop shaft angle and the torque reaction of the propeller. You can adjust the prop shaft angle by activating the trim switch on the shifter lever. Small adjustments should be made until the steering has neutral torque (does not pull in either direction) at the speed you desire.

## Instruments

---

While under way, instruments should be checked frequently for possible indications of trouble.

1. **Tachometer**—A tachometer is an electrical instrument that indicates engine revolutions per minute (RPM). The tachometer is useful for monitoring engine speed to avoid exceeding the maximum RPM rating. In addition, it can be used to detect performance changes by comparing speedometer readings at various RPMs.
2. **Temperature Gauge**—The temperature gauge indicates engine coolant temperature by monitoring a signal from a sending unit installed in the engine water jacket. When the gauge reads in the danger area, shut off the engine and diagnose the problem. A common cause of overheating is picking up a foreign object in the seawater intake. Usually, raising and lowering your stern drive will free it. Backing up in reverse gear, then pulling ahead in forward gear for 10-15 feet is helpful, too.
3. **Oil Pressure Gauge**—The oil pressure gauge indicates engine lubricating oil pressure. Low oil pressure readings are generally caused by low oil quantity. In any case, immediately shut down the engine and diagnose the problem.
4. **Fuel Gauge**—The fuel gauge indicates approximate fuel level. Since boats are exposed to rough water conditions and varying degrees of trim, it is usually not possible to fill the fuel tank to 100% of its dry-rated capacity. Therefore, fuel gauges may seem to provide inaccurate readings at times. It is always good to keep track of the amount of fuel you pump aboard, as well as your running time and estimated fuel usage as a double check against an inaccurate gauge. Be sure to follow the recommended fueling procedures in the operating section of this manual.
5. **Compass**—Your boat may come equipped with a compass for use in navigation. Many factors affect the operation of your compass, such as local magnetic variation and deviation (induced needle deflection caused by metal components and the operation of electrical equipment aboard your boat). Each compass must be "swung" (compensated) to adjust for individual boat characteristics, and for the particular compass installation. It is vitally important, therefore, that you have your compass professionally swung before using it for marine navigation. Your Bayliner dealer can refer you to local shops that perform this work.

## COMPONENTS/SYSTEMS

---

### Electrical System

---



#### **DANGER**

To minimize the risks of fire and explosion, **NEVER** install knife switches or other arcing devices in fuel compartments.



#### **DANGER**

**NEVER** substitute automotive parts for marine parts. Electrical, ignition and fuel system parts on your boat are designed and manufactured to comply with U.S. Coast Guard Rules and Regulations to minimize risks of fire and explosion.



#### **WARNING**

To reduce the risk of fire or explosion only qualified personnel should install batteries and perform electrical system maintenance. You can minimize the danger of fire and explosion by not exposing the batteries to open flame or sparks. It is also important that no one smoke anywhere near the batteries. Because fuel fumes are heavier than air, they will collect in the bilge areas where they can be accidentally ignited. Operating the bilge blower for at least four minutes prior to engine starting, electrical system maintenance, or activation of electrical devices will decrease the danger of fire and explosion.

#### **NOTICE**

Electrical connections are susceptible to corrosion. To help prevent electrical malfunction due to corrosion, keep all exposed electrical connections clean and protect them with a good quality spray-on protectant such as Corrosion Guard®.

Although Bayliner manufactures many different models of powerboats, the electrical systems on all models operate on the same basic theory.

1. *Battery:*

The key to a good marine electrical system is the battery (the batteries are dealer-installed items). Bayliner makes the following recommendation on battery rating:

**Stern Drive Models — 500 cold cranking amps minimum**

The condition of the battery can be read on the voltmeter when the ignition switch is in the ON position.

With the engine not running, voltmeter readings in the 11.5 to 12.5-volt range are considered normal. Readings in the 10 to 11.5-volt range indicate a marginal charge condition. Readings below 10 volts indicate a seriously discharged condition.

With the engine running (over 1500 RPM), voltmeter readings of 13 to 14 volts are considered normal. Readings below this indicate a severely discharged battery or a nonfunctioning charging system.



**CAUTION**

**The battery charging system (alternator) installed is designed to charge a conventional lead-acid battery. Before installing a gel-cell or other new technology battery, consult with the battery manufacturer about charging system requirements.**

Check the battery electrolyte level regularly. Remove the caps on top of the battery and observe the level of the fluid inside. If the zinc plates are exposed, add distilled water until they are covered again. Corroded terminals can impair battery performance and charging ability. Clean them with baking soda and water; then coat them with a terminal protectant or a light film of grease. Be sure all battery connections are tight. When storing the boat, it is best to remove the battery, give it a full charge, and store it inside away from extreme temperatures.



**CAUTION**

**Never disconnect battery cables or turn the main battery switch(es) to the OFF position while the engine is running, as this can cause damage to your boat's electrical components.**

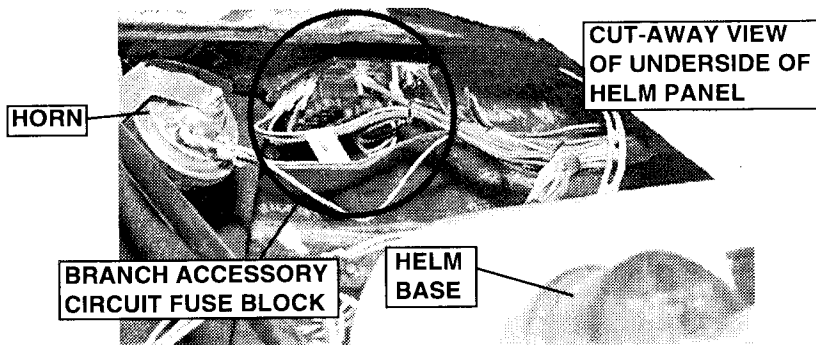

## 2. *Fuses and Circuit Breakers:*

On all stern drive models, both the engine and accessory circuits are protected by a large circuit breaker located on the engine. In addition, a fuse block for branch accessory circuits is located behind the helm panel. Wires are color coded to indicate which accessory each fuse services. Some items, such as radios and bilge pumps, may be fused individually at the unit. Auto float switches are fused at the battery. A wiring diagram is provided at the back of this manual.

## Starter Motor

The engine starter motor is designed to deliver high horsepower for very short periods of time. Avoid operation for more than 15 seconds at a time. Allow at least one minute for cooling between start attempts. This motor builds up considerable heat and can be permanently damaged with prolonged use. If it does not operate, check the battery charge and all direct wiring for shorts or loose connections. The starter can be damaged in stern drive models if excess bilge water is allowed to come in contact with it. Automatic bilge pumps are recommended for boats left in open moorage.

## Bilge Blower

Your boat is equipped with a bilge blower that removes fumes from the engine compartment and draws fresh air into the compartment through the deck vents.

To insure fresh air circulation, the bilge blower is to be used before starting the engine, during starting, and while the boat is operating below cruising speed. **Operate the blower for at least four minutes before starting the engine.**

### **WARNING**

Operation of the blower is **NOT A GUARANTEE** that explosive fumes have been removed. If you smell any fuel, shut off the engine and all electrical accessories and investigate immediately.

## Bilge Pump

The electric bilge pump supplied with your boat is an impeller-type pump. It is controlled by a switch on the dash panel, which should be activated whenever water begins to accumulate in the bilge. Some models will also have an automatic bilge pump switch ("autofloat switch") mounted next to the pump. This is a float-type switch that will activate the bilge pump automatically whenever bilge water accumulates above a pre-set level. It is wired directly to the battery so it will normally function even when the boat is completely shut down and unattended, such as when the boat is moored at a marina.

Operation of the bilge pumps should be checked frequently. To check the bilge pumps, activate the dash-mounted switch and verify that any water in the bilge is pumped overboard. If bilge water is present and the pump motor is running but not pumping, check to see if the pump housing is clogged with debris:

- Lift the tab while rotating the fins counter clockwise and lift out the power cartridge (Fig. 1).
- Clear the housing of debris.

To reinstall the power cartridge:

- Make sure the "O" ring is properly located and coat the "O" ring with a light film of vegetable oil or mineral oil (Fig. 2).
- Align the two cams on either side of the power cartridge with the two slots in the outer housing. Press the power cartridge into the housing and twist clockwise. Ensure proper reinstallation by attempting to twist the fins counter clockwise without lifting the tab. The cartridge should stay in place.

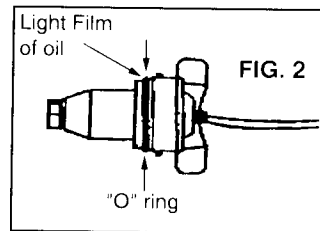
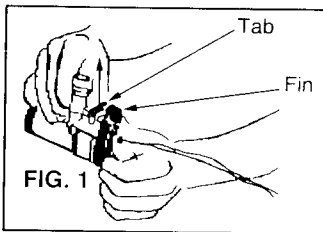

If the pump is clear but still does not move water, check the discharge hose for kinks or a collapsed area.

The autofloat switch should also be checked frequently for proper operation. The plastic insert, where the wires enter the housing, should rotate 1/4 turn counter clockwise (lifting the float).



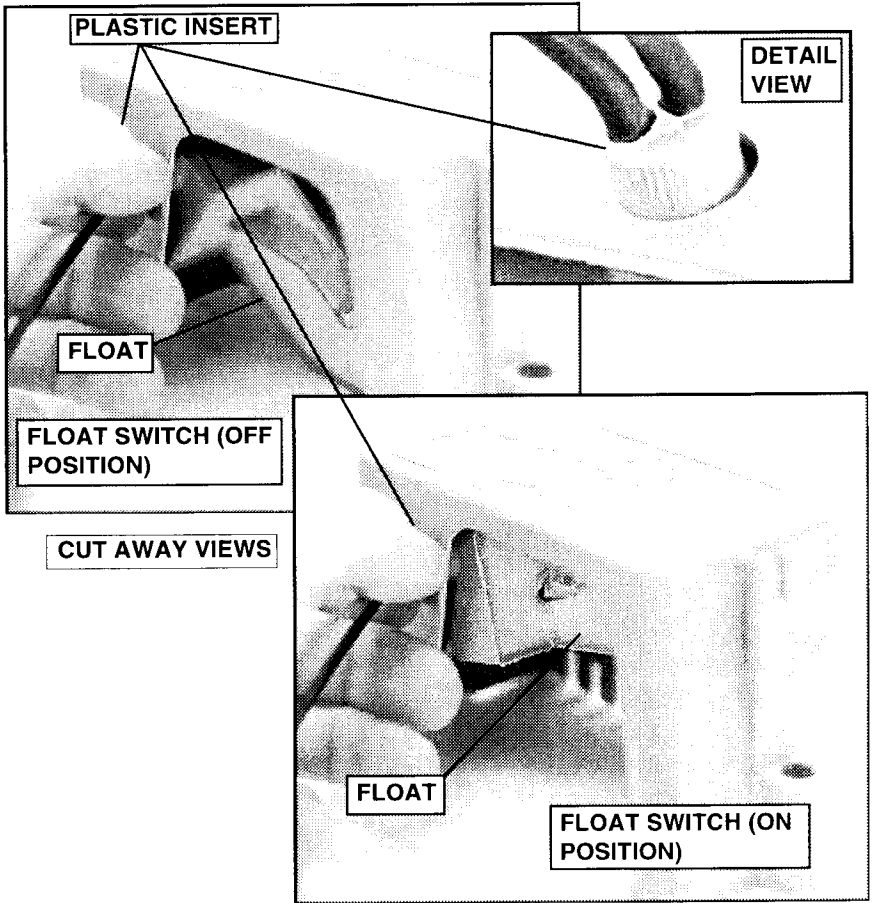

As you raise the float to its full upward position, the bilge pump should turn on. If raising the float does not switch the pump on, check the inline fuse at the battery switch board. Make sure it has not blown. If the fuse is good, but the switch still does not work, it usually indicates a bad switch, or possibly a low battery. In either case, call your dealer for further assistance.

## NOTICE

The Federal Water Pollution Control Act prohibits the discharge of oil or oil waste into or upon the navigable waters and contiguous zone of the United States if such discharge causes a film or sheen upon, or discoloration of, the surface of the water, or causes a sludge or emulsion beneath the surface of the water. Violators are subject to a penalty of \$5000.

## Navigation Lights

---

Vessels are required to have navigation lights turned on from "dusk to dawn" or in conditions of reduced visibility. It is wise to run at reduced speed whenever navigation lights are needed. Although the navigation lights supplied with your Bayliner are of top quality, failure may occur for a variety of reasons:

1. There may be a blown fuse. (Replace the fuse in the fuse block.)
2. The bulb may be burned out. (Carry spare bulbs for replacement.)
3. The bulb base may be corroded. (Clean the base periodically and coat it with nonconductive grease.)
4. A wire may have come loose or may be damaged. (Repair as required.)

### NOTICE

**Prolonged operation of cabin interior lights (overnight) will result in a dead battery. Be conservative in the use of battery power.**

## Fuel System

---



### CAUTION

**It is very important that the fuel system be thoroughly inspected for leaks the first time it is filled and then at each subsequent filling. For your safety and the safety of your passengers, the fueling instructions in this manual must be followed.**

#### 1. *Fuel Fills and Vents:*

Fuel fills are located either on the aft deck or on the side decks adjacent to the aft cockpit. Fuel receptacle caps are marked "Fuel" or "Gas". Fuel vents are normally located in the hull or transom below and in the same general area as the fill or as an integral part of the fuel fill fitting. If you experience difficulty filling the fuel tank, check to see that the fuel fill and vent lines are free of obstructions and kinks.

#### 2. *Antisiphon Valves:*

As required by the U.S. Coast Guard, your fuel system is equipped with an antisiphon valve. This valve is an integral part of the barb fitting on the fuel tank to which the neoprene fuel line attaches. The valve is spring loaded and is opened by fuel pump pressure. These valves will prevent gasoline from siphoning from the fuel tank in the event of a fuel line rupture.

## Portable Head

---

Be sure to read and carefully follow the manufacturer's instructions.

1. *To Fill the Freshwater Tank:*

Remove the upper section from the lower section. Remove the fill cap and fill to the maximum waterline level on the side of the tank. **DO NOT OVERFILL. DO NOT POUR WASTE TANK DEODORIZER INTO THE FRESHWATER TANK.**

2. Before use, always check the pressure build-up by pulling out the flush handle slowly with the lid closed. It is necessary to pump liquid into the basin. Keep the basin dry when not in use.

### NOTICE

**Use only white toilet tissue, as colored dyes may impair the effectiveness of the chemical. Use regular ply tissue. Do not use disintegrating tissue as this may clog the entire pump system.**

3. *To Flush:*

Pull the holding tank flush valve handle straight out. To rinse the bowl, stroke the pump several times. Next, slowly push the valve handle straight in. This will ensure a leakproof seal.

4. *To Add Chemical Deodorizer:*

Pull the flush valve handle straight out so that the bowl clapper seal is completely open. Add the chemical to the tank according to the manufacturer's instructions. Pump sufficient water through the bowl opening to cover the bottom surface of the lower tank.

### NOTICE

**Do not add holding tank chemical to the upper fresh-water tank. Also, do not add odor control chemical to the bowl while the bowl clapper seal is closed.**

5. *Cleaning:*

Use only mild cleansers, detergents or soaps (avoid using abrasive cleaners). Clean the toilet periodically.

6. *To Empty:*

The unit is ready to be emptied when the contents of the holding tank approach a level of 2 cm below the surface of the bowl clapper seal.

Make sure the flush valve handle is closed. Disengage and remove the freshwater tank from the holding tank. Unscrew the holding tank cap while the tank is in a horizontal position. Pull up on the air vent valve (red cap located on the top, front, left-hand corner of the tank). Carefully empty the holding tank by grasping the tank in the front and back and slowly tilting.

After emptying the tank, rinse with fresh water, replace the cap, push the air vent valve closed, reassemble and recharge the unit.

## **NOTICE**

**There are many brands of toilet chemicals, any of which will work very well in any of the portable toilets supplied by US Marine.**

7. *Winter Usage:*

For cold weather use, add a nontoxic winter protector antifreeze to the freshwater supply tank to prevent it from freezing.

8. *Storage:*

Empty both the water tank and the holding tank. Rinse out the holding tank with a 5% solution of bleach and water (50 ml of bleach per litre of water).

## **AM/FM Cassette Stereo**

---

The AM/FM cassette stereo that comes standard with your Bayliner has a separate manual that explains its operating features. Note that AM radio reception will be impaired anytime the engine is running.

# Seat Adjustment

Your boat may be equipped with adjustable sleeper seats. These seats can be adjusted for and aft in the upright position. The seat bottoms of these models also adjust into backrests while the seat is in the lounge position.

### *Fore - aft adjustment:*

1. To slide the seat forward or backward lift up on the front edge of the seat bottom(A). Move the seat forward until the locking mechanism engages in one of the three different positions. Lift the aft seat at point (B) and slide the aft seat towards the forward seat.

### *Lounge positions:*

1. To put seat into the lounge position lift on the front of the edge of the seat (A) and pull the seat all the way forward. Lift the aft seat at (B) and pull the aft seat away from the forward seat until the seat is laid out flat.
2. Lift up on the forward or aft seat bottom at point (C) until the seat bottom drops into the locked position.
3. To lower the seat bottom, lift up the seat at points (C) and (D) at the same time. Drop the seat bottom flat while holding the seat up at point (D).
4. To return the seat to the operating position, lift the seat back at point (E) and push the seat bottom toward the center of the seat until it locks into place.

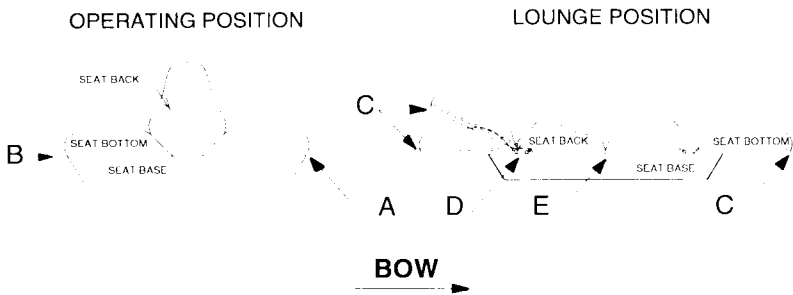

## Canvas Top Installation

---

1. Attach eye ends of main bow (#1 in the accompanying illustration) to deck hinges on the boat and remove boot if necessary.
2. Unfold canvas top and stretch the front edge of the top across the windshield frame and snap to frame (#2). Use care to center canvas on the windshield. Close the front zipper.
3. Pull back on the top (#3), and making sure the canvas lies evenly from side to side, hook the hold down straps (#4) to the deck loops located near the rear of the windshield side wing. If the canvas top does not have a smooth, taut look, adjust by pulling up on the strap buckle while holding the rear of the top. When properly adjusted both sides of the top will be even.
4. Check that the secondary bow (#5) aligns with the center seam of the canvas. Adjust if necessary by loosening or tightening the top straps (#6). No adjustments to the secondary bow jawslide (#7) should need to be made as they are preset. Before attempting to adjust the jawslide position, obtain the correct measurements from your Bayliner dealer.
5. If additional canvas (i.e. side curtains, slant back cover, or camper cover) is to be installed it should be snapped to the top canvas before final adjustment. The top can then be adjusted, as in steps 3 and 4, to bring the lower row of snaps on the canvas in line with the row on the boat. Like the top, the additional canvas pieces are in proper adjustment when they are smooth and taut.

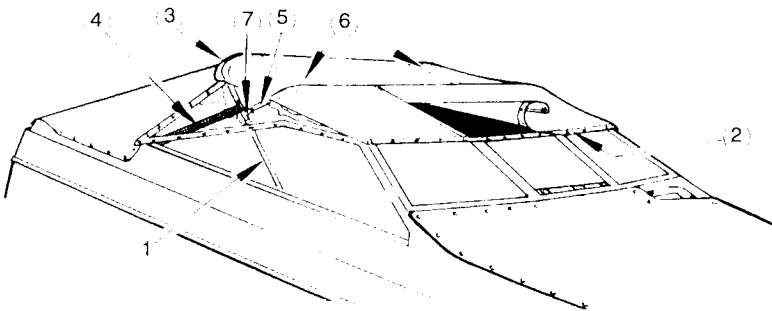

## GENERAL MAINTENANCE AND REPAIRS

---

In addition to instructions found elsewhere in this manual and in the literature specific to certain components, the following information is provided for general maintenance and repair.

Because conditions vary widely in different areas, and the frequency and type of use can differ greatly between owners, intervals for maintenance are not listed here. Common sense should determine the frequency of maintenance.

### Bilges/Engine Compartment

---

1. Pump the bilges dry and remove all loose dirt. Be sure that all limber holes are open. If there is oil in the bilge and the source is not known, look for leaks in engine oil lines or engine gaskets. Oil stains can be removed by using a bilge cleaner available from your dealer or a marina. **DO NOT** use flammable solvents.
2. Check all wiring to be sure it is properly supported, that its insulation is intact, and that there are no loose or corroded terminals. If there are corroded terminals, they should be replaced or thoroughly cleaned. Tighten all terminals securely and spray them with light marine preservative oil.
3. Inspect the entire fuel system (including fill lines and vents) for any evidence of leakage. Any stains around joints could indicate a leak. Try a wrench on all fittings to be sure they are not loose, but do not overtighten them. Clean fuel filters and vent screens.
4. Inspect the entire bottom for evidence of seepage, damage or deterioration, paying particular attention to hull fittings, hoses and clamps. Straighten kinked hoses and replace any that do not feel pliable. Tighten loose hose clamps and replace those that are corroded. Tighten any loose nuts, bolts or screws.
5. Refer to your engine operating manual for engine maintenance details. Wipe off engines to remove accumulated dust and grease. If a solvent is used, make sure it is nonflammable. Go over the entire engine and tighten nuts, bolts, and screws, including the mounts. Inspect the wiring on the engine and clean and tighten the terminals. Inspect the belts and tighten them if needed. Replace any belt that is cracked or frayed. Clean and lubricate the battery terminals; fill the battery cells with distilled water as needed.

## Topside Areas

---

1. Check bow rails, ladders and grab rails for loose screws, breaks, sharp edges, etc., that might be hazardous in rough weather. Inventory and inspect life jackets for tears and deterioration. Check your first aid kit to make sure it is complete. Check the signaling equipment. Inspect anchor, mooring and towing lines and repair or replace as required. DO NOT stow wet lines or they may mildew and rot.
2. Salt and brackish water are capable of etching and damaging window glass. Keeping the windows clean is the best preventive measure you can take. When window cleaning, flush with plenty of fresh water. Plexiglass tends to scratch easily. Exercise caution when cleaning windows and doors made of plexiglass. First, use generous amounts of water to wash off as much dust as possible. Use your bare hands with plenty of water to dislodge any caked dirt. Then use a soft, grit-free cloth or soft, clean sponge with a cleaner made specifically for plexiglass. Glass cleaning solutions and dusters will scratch the surface and should not be used. DO NOT use solvents such as acetone, kerosene, benzine, carbon tetrachloride, fire extinguisher fluid, dry cleaning fluid, or lacquer thinner since they will attack the surface. When you are finished, rinse with fresh water and dry with a clean, damp chamois using a blotting action.
3. To keep teak looking fresh, it should be treated with teak oil at least twice a year (more often if exposure is severe). If the teak is in particularly bad condition, ask your Bayliner dealer for a good teak refurbishing kit.
4. Stainless steel railings and fittings should be cleaned with soap and water or household glass cleaner. Because irreversible pitting will develop under rust that remains on stainless steel for any period of time, it is best to remove rust spots immediately with brass, silver or chrome cleaner. Then coat the railing or fitting with a good automobile or boat wax. Never clean with mineral acids or bleaches. Also, do not allow stainless steel to come into continuous contact with iron, steel or other metals which could cause contamination leading to rust or corrosion.
5. A variety of high quality fabrics have been used in the construction of your boat. Proper care and cleaning of all fabrics on a regular basis will contribute to their long life. The most important thing to remember is that stains must be cleaned up immediately if the original beauty and strength of the fabric are to be maintained over a long period of time. Independent laboratory testing has shown that some sunscreen lotions and oils can permanently stain most types of vinyls and fabrics, so exercise care when using these products.



Prior to cleaning any fabric, we suggest that you test your cleaning solution and method on a hidden or inconspicuous area. That way, if that particular cleaning method causes damage, it will be confined to a small, less noticeable area.

Use a sponge or very soft scrub brush and a mild soap and warm water solution to clean exterior fabrics. Rinse after scrubbing with plenty of cold, clean water and allow the fabric to air dry in a well ventilated place, preferably away from direct sunlight.

Convertible tops, Naugahyde® dash panels (if your boat is so equipped), and vinyl upholstery can be cleaned using a mild soap and warm water solution also. Rinse after scrubbing with plenty of cold, clean water and air dry in a well ventilated place, again preferably away from direct sunlight. For detailed vinyl cleaning instructions see the Nautolex® insert in your owner's packet.

Vinyl cleaners and conditioners are NOT recommended for use on Bayliner upholstery, as they tend to remove plasticizers that extend the life of the fabric. To prevent rainwater seepage at the seams, a coating of Scotch Gard® can be applied.

Mildew can occur if your boat does not have adequate ventilation. Heat alone will not prevent mildew; you must also provide for fresh air circulation. If mildew does occur, it often can be removed using a solution of warm water and laundry bleach (one cup of bleach to one gallon of warm water). Brush the solution into the affected area, let it sit for 10 to 15 minutes, and rinse with plenty of cold, clean water. Air dry in a well ventilated place, once again preferably away from direct sunlight.

If at all possible, the vinyl top parts of your boat should be stored indoors in a fairly warm, dry place. This will greatly extend the life of the material.

Dry cleaning should be considered for interior fabrics other than vinyl.

6. When instruments are exposed to a saltwater environment, salt crystals may form on the bezel and the plastic covers. These salt crystals should be removed with a soft, damp cloth; never use abrasives or rough, dirty cloths to wipe plastic parts. Mild household detergents or plastic cleaners can be used to keep the instruments bright and clean.

## Hull

---

1. The finish on a fiberglass boat is similar to that of an automobile and will respond to the same system of care and cleaning.

Use a sponge and a mild soap and warm water solution to clean exterior surfaces of your boat. Rinse the boat well with plenty of clean water. Use a quality boat wax to protect the finish, but avoid waxing polyethylene swim platforms, as they can be destroyed by the chemicals in some waxes. There are a variety of polishes and cleaners for fiberglass on the market. We suggest that you experiment with different brands to determine which work best for you.

2. Almost unavoidable during the life of your boat is damage to the gelcoat or colored surface. This is not as serious as you might think. Repair is not costly and can be done by the novice.

*Scratches:* If the scratch does not penetrate the gelcoat surface, it can be repaired with automotive rubbing compound. Dampen a soft rag and apply the compound by rubbing in a circular motion. The scratch may not disappear completely; however, its noticeability will decrease.

*Gouges and Chips:* To repair, obtain "patch paste" from your Bayliner dealer and follow this recommended procedure:

- Clean the area to be repaired of wax and oil. Acetone is a good solvent.
- Mix a small portion of patch paste and catalyst on a piece of cardboard according to the manufacturer's instructions.
- Apply the paste to the gouge with a putty knife or flat-edged stick; try to match the paste to the surface contour of the area being repaired. It is better to have an excess of paste, rather than not enough.
- Allow the paste to harden thoroughly. In most climates, one to two hours should be sufficient.
- Shape the patch as desired using fine wet sandpaper.
- Finish by using automotive rubbing compound in the same manner as you did for small scratches.



### WARNING

**Teak oil, acetone and catalyst are hazardous materials and should be used only in well ventilated areas. Follow the manufacturer's instructions. Also, never store rags that have been wetted with acetone, teak oil, fuel or any other solvent aboard your boat. Immediately remove them from the boat and discard them to prevent spontaneous combustion and fire.**

### 3. Special Care for Boats That Are Moored

If moored in saltwater or fresh water, your boat will collect marine growth on its bottom. This will detract from the boat's beauty and greatly affect its performance. There are two methods of preventing this:

- Periodically haul the boat out of the water and scrub the bottom with a bristle brush and a solution of soap and water.
- Paint the hull below the waterline with a good grade of antifouling paint.

## NOTICE

**Bayliner recommends the application of an epoxy barrier coating, such as International Paint Company's Interlux "Interprotect 2000 or 3000 System®", to help seal the hull bottom and reduce the possibility of gelcoat blistering on any boat that is moored. The barrier coating should be covered with several coats of antifouling paint. Note that many states regulate the chemical content of bottom paints in order to meet environmental standards. Check with your local Bayliner dealer about recommended bottom paints, and about laws that are in effect in your area.**

4. Whenever your boat is out of the water you should check all metal parts for stray current corrosion. Stray current corrosion, or electrolysis, can be prevented several ways. The following are the most common causes and the simplest cures:
- Wiring may leak a certain amount of electricity. Keep a clean, dry bilge.
  - A poorly grounded zinc anode: Check the ground wire and clean all contact surfaces.
  - The zinc anode may be deteriorated beyond effectiveness. Replace it when it has deteriorated 50% or more.
  - If your boat is moored, we recommend that you contact someone in your area specializing in corrosion control and have them check your boat in its moorage to see that it is properly protected.
5. Propellers should be inspected often for damage. Every attempt has been made to equip your boat with a propeller that will optimize performance. However, your boating needs may dictate a propeller change. Your Bayliner dealer can help you in the selection of propellers better suited to your needs.

## STORAGE

---

The following suggestions are offered for storage at the end of your boating season.

1. Your boat should be stored under cover if possible. If covered storage isn't available, a temporary winter cover is recommended. A proper winter cover should keep weather off the boat, but still provide adequate ventilation. Wrapping a boat up in a tight plastic cover can do more damage than good. Dampness and lack of air circulation provide ideal conditions for fungi that cause mildew and dry rot.
2. If you are storing your boat on its trailer:
  - Now is a good time to repack the trailer's wheel bearings. Your local auto service center can help you.
  - Block the trailer wheels off the ground to avoid tire deterioration.
  - Loosen the stern tie-downs to avoid stress on the hull.
3. Refer to your engine manual for engine storage instructions.
4. Remove the marine battery from the boat. Fill the cells to the proper level and store your battery in a warm place. A fully charged battery will survive storage better.
5. Fuel tanks should be filled so there is little air space, thereby minimizing condensation.
6. Thoroughly clean your boat. If possible, remove cushions, mattresses, blankets, towels, and other items that can hold moisture and cause mildew. Such items left on board should be positioned for maximum air circulation. Stand mattresses and cushions on edge. Prop open doors, hatches, cabinets and ski lockers to allow fresh air to circulate.
7. Clean all deck hardware; then coat the hardware with rust inhibitor.
8. Lubricate the steering mechanism and throttle control linkage.
9. Consult the instructions provided with your head (toilet) for the correct winterizing procedure. Drain self-contained heads.

We hope these preventive measures will help make getting ready again in the spring easier. Should you have any questions, your Bayliner dealer is eager to provide assistance.

## NAUTICAL TERMS

---

- ABEAM:** ..... To one side of a vessel, at a right angle to the fore-and-aft line.
- AFT:** ..... Near or at the stern.
- BEAM:** ..... The width of the hull.
- BILGE:** ..... The lowest portion inside a boat (in a fiberglass boat, generally the underdeck and lower portion of the engine compartment).
- BOW:** ..... The forward portion of the boat.
- CHINE:** ..... The intersection of the side and bottom of a V-bottom boat.
- DRAFT:** ..... Vertical distance from the waterline of the boat to the lowest point of the boat.
- FATHOM:** ..... A measurement of six feet, generally used to measure water depth.
- FREEBOARD:** ..... Vertical distance from the deck to the waterline.
- GUNWALE:** ..... The upper edge of the side of a boat.
- HATCH:** ..... A deck opening providing access to the space below. Normally fitted with a cover.
- HEAD:** ..... Toilet or toilet room.
- HELM:** ..... The tiller, wheel, and other steering gear.
- KEEL:** ..... The lowest external portion of the hull.
- KNOT:** ..... Nautical mile per hour; one nautical mile is 6,076 ft.; a land mile is 5,280 ft.
- LEE:** ..... The direction toward which the wind blows.
- PORT:** ..... To the left side of the boat facing forward.
- PORTLIGHT:** ..... A hinged window in the boat's cabin or hull.
- SCUPPER:** ..... An opening in a deck or cockpit permitting water to drain overboard.
- STANCHION:** ..... A fixed, upright post used for support (of rails or lifelines).
- STARBOARD:** ..... To the right side of the boat facing forward.
- STERN:** ..... The aft portion of the boat.
- STERN DRIVE:** ..... Inboard/outboard propulsion unit.
- TRANSOM:** ..... The transverse part of the stern.
- WINDWARD:** ..... The direction from which the wind is blowing.

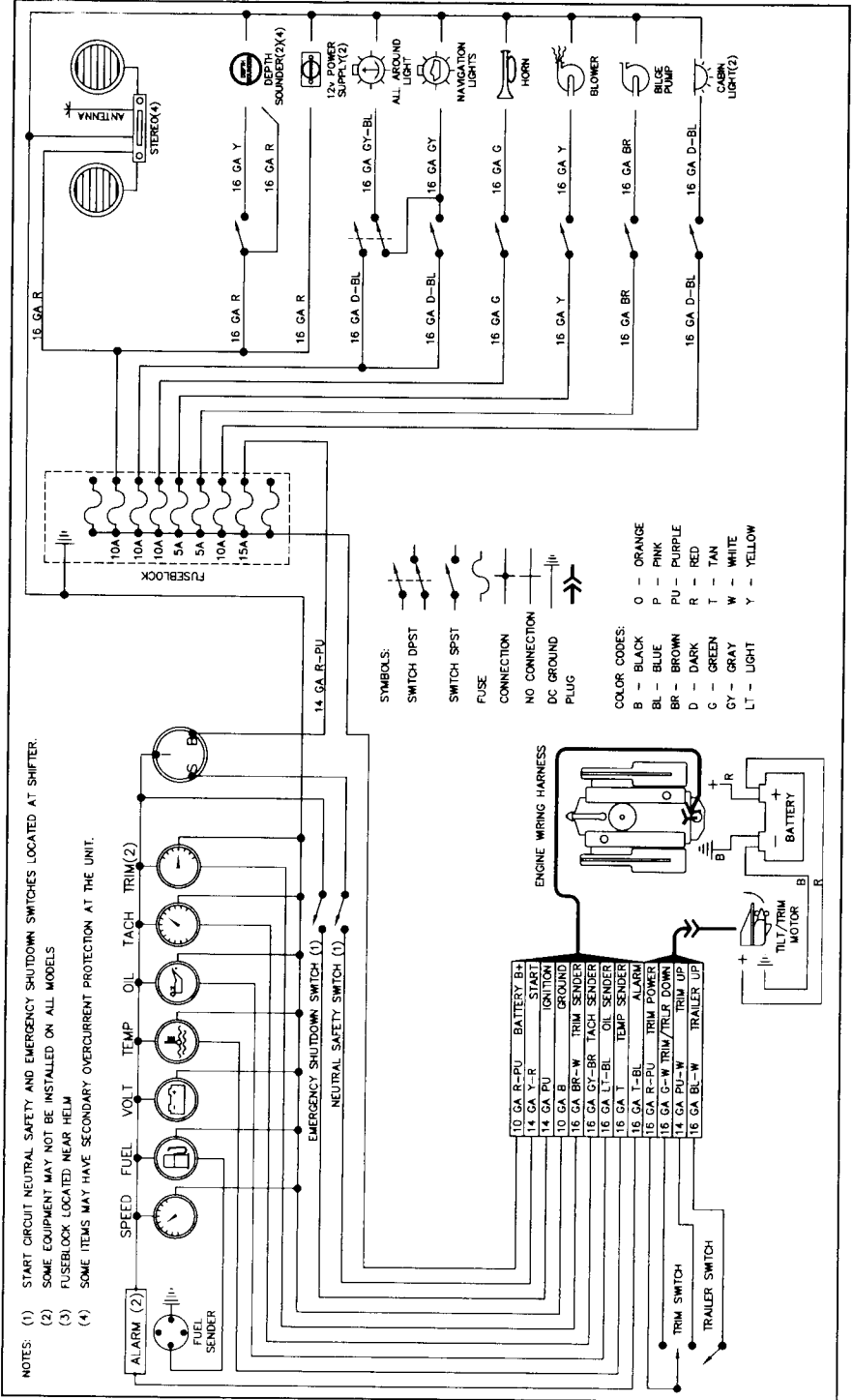

**This page is  
intentionally blank**

